

**Canon**

# **EOS R SYSTEM**

WHITE PAPER



**A New Lens-Camera System**

Written by Larry Thorpe, Canon U.S.A., Inc

## Content

|   | <b>Page</b> |
|---|-------------|
| Abstract  | 1           |
| 1.0 HISTORY OF THE EOS SYSTEM                                     | 1           |
| 2.0 EOS SYSTEM EXTENDS TO DIGITAL CINEMA                          | 2           |
| 3.0 LIMITATIONS OF THE CURRENT EOS SYSTEM                         | 4           |
| 4.0 A CHANGING GLOBAL MARKETPLACE                                 | 4           |
| 5.0 AN IDEAL LENS CAMERA SYSTEM                                   | 5           |
| 6.0 EXTENDING LENS DESIGN OPTIONS                                 | 5           |
| 7.0 KEY TO A NEW GENERATION OF LENSES — NEW LENS MOUNT            | 7           |
| 8.0 DETAILS OF THE NEW CANON RF MOUNT                             | 8           |
| 9.0 CHALLENGE OF MANAGING LENS ABERRATIONS                        | 10          |
| 10.0 NEW CONCEPTS UNDERLYING RF LENSES                            | 12          |
| 10.1 New Feature Unique to RF Lenses                              | 12          |
| 10.1.1 Control Ring   | 12          |
| 10.1.2 Aperture Blade Control                                     | 12          |
| 10.1.3 Focus Ring Rotation Direction Change                       | 13          |
| 10.1.4 Enhanced Electronic Communication between Lens and Camera  | 13          |
| 11.0 INTRODUCTORY FAMILY OF RF LENSES                             | 13          |
| 11.1 RF28-70mm F2 L USM   | 14          |
| 11.2 RF50mm F1.2 L USM  | 19          |
| 11.3 RF24-105mm F4 L IS USM                                       | 22          |
| 11.4 RF35mm F1.8 MACRO IS STM                                     | 27          |
| 12.0 EF LENS MOUNT ADAPTERS                                       | 30          |
| 13.0 EOS R LENS-CAMERA SYSTEM                                     | 32          |
| 13.1 Enhanced Image Stabilization System                          | 32          |
| 13.2 Digital Lens Optimizer (DLO) System                          | 34          |
| 13.3 Dual Pixel CMOS AF System                                    | 36          |
| 13.4 Comparison of EOS R lens-camera system with EF lens and DSLR | 39          |
| 14.0 SUMMARY  | 41          |

## Abstract

*The Canon EOS system is comprised of EF lenses, EF-S lenses, and associated cameras. This system is now thirty years old. It remains robust and innovative. These interchangeable lens-camera systems service multiple levels of the global imaging marketplace — from the highest professional levels to the aspiring new photographers within the larger consumer base. But today, both still photography and motion imaging are branching out in multiple directions — propelled by a movement spawned a decade ago with the arrival of the hybrid interchangeable lens-camera. Today, even high end moviemaking and television production quite readily incorporate Canon EOS lenses and cameras into their arsenal of image acquisition tools. Separately, social media and diverse web-based services are spawning new businesses and creative initiatives in still and motion imaging.*

*While the quest for more resolution remains, the past decade has also seen a rapidly growing awareness of other dimensions of image quality — color reproduction, dynamic range, and picture capture rates. Mirrorless cameras have emerged and have a growing following. Shooting practices are unceasing in their diversity and ingenuity.*

*Assimilating all of these movements on a worldwide scale led Canon to the conclusion that a juncture has been reached where new flexibilities were imperative to expand the possibilities of the Canon EOS system to support future decades of both still and motion imaging — in all of their manifestations. Given that optics is the very core of Canon led to a conclusion that new lenses offering important enhancements must constitute the spearhead of this initiative. In turn, this would be predicated on the design of a new lens mount that would empower lens developments to be taken to new levels. Continuing support of EF and EF-S lenses would be factored into the new system design.*

*This white paper will discuss in some detail the new lens mount design and its implications for an important new generation of lenses and cameras.*

## 1.0 HISTORY OF THE CANON EOS SYSTEM

In 1987 Canon launched a new imaging system that transformed the world of photographic imaging. The Canon EOS system was squarely based upon an innovative new lens mount that had the following attributes:

1. Large 54mm inner diameter mount — termed the EF mount
2. Flange back distance of 44mm
3. Flexible electronic communication between lens and camera.
4. Large diameter mount opened broad options in lens design.

It allowed large aperture lens designs that maintained high optical performance. Central to this design was the total absence of mechanical linkages between the moving parts within the lenses and the camera.

All operational functions were supported by the electrical communication between the lens and camera. This communication allowed focusing motors to be optimally positioned within each individual lens design, which supported fast auto focus systems. The aperture control was also electronic which supported auto-aperture functionalities. In the ensuing decades these core design strategies empowered a progressive imaging evolution that witnessed the emergence of an extraordinary broad range of zoom and prime lenses that were flanked initially by SLR 35mm film cameras and ultimately the arrival of the all-digital DSLR camera in the early 21<sup>st</sup> century.

In 1995 the first lens with built-in image stabilization system became possible based upon that electronic communication (the EF75-300mm f/4-5.6 IS USM). The lens-camera movements detected within the lens itself are processed and control signals generated that actuate correction optics within the lens. That large diameter mount and the electronic communication continue to empower new features in both lens and camera to this day. And the paced expansion of EF lenses and cameras over the years speaks a great deal about the success of this remarkable design strategy.



**Figure 1** *Three decades of the Canon EOS system has seen an impressive evolution of lenses and cameras that presently serve a worldwide market at many levels*

## **2.0 CANON EOS SYSTEM EXTENDS TO DIGITAL CINEMA**

Today's world production community — both theatrical motion picture and episodic television — will utilize all manner of lens-camera combinations to achieve their creative aspirations and meet their production budgets. Major movies have been produced that incorporated DSLR's coupled to digital cinema lenses and high-end digital cinema cameras using EF lenses.



**Figure 2** *The global production communities freely “mix ‘n match” lenses and cameras*

In 2011 Canon leveraged the vast accumulation of experiences in the broadcast television optics business and that of the now firmly established Canon EOS system to enter the digital cinema world with a family of high-end professional digital cinema lenses (both primes and zooms) and cameras — the Canon Cinema EOS system. This system was designed to utilize the EF mount — while also offering the option of the established cinematography PL mount on the higher end products within this family. While distinctly different in their respective target markets both lens-camera families benefited greatly from the shared technologies. This systemization offered the production world great flexibilities in combining A-Cameras with a range of choices in B-camera and C-camera options.



**Figure 3** *Suggesting the technological overlap between the Canon EOS still photography systems (left and center) and the Canon Cinema EOS motion imaging system on the right*

### **3.0 LIMITATIONS OF THE CURRENT EOS SYSTEM**

Assessing the current EOS system in the context of future considerations exposes some limitations as follows:

1. Insufficient flexibilities in mount diameter and back focus distance to accommodate all of the increasingly diverse requirements in zoom and prime lenses
2. Limited speed of the electronic communication between lens and camera
3. Limited electronic channels between lens and camera to accommodate new operational aspirations
4. Constraints in sensor-based AF operational capabilities

Collectively, these considerations make a compelling case for a more encompassing approach to the interchangeable lens-camera system going forward. A new lens system is pivotal to form an underpinning core to the new EOS R system.

### **4.0 A CHANGING GLOBAL MARKETPLACE**

Digital imaging has been with us for almost a quarter century. But, the past decade has seen extraordinary advances in both image performance and creative flexibilities offered by contemporary lenses and cameras. The former lines separating still and motion imaging are blurred, image resolution has soared, and end user demands for more operational empowerments are unceasing. Applications of interchangeable lens-camera systems continually broaden.

## 5.0 AN IDEAL LENS-CAMERA SYSTEM

Three decades after the debut of the Canon EOS system Canon believes that new and broadening marketplace dynamics require an extension to the original design premise of the EF interchangeable lens-camera system. An ideal lens-camera system intended for future years in imaging would include the following contemporary considerations:

1. Emerging popularity of the full frame image sensor
2. Anticipated progressive elevation of sensor resolution
3. Quest for higher exposure ranges
4. Increasing diversity and sophistication of end-users seeking extended operational functionalities

All of these considerations bear directly on the lens and lens mount designs.

## 6.0 EXTENDING LENS DESIGN OPTIONS

There continues to be an inexorable growth in the needs and aspirations of the multiple creative communities presently engaged in both still and motion imaging. Widely differing needs in zooms and primes encompass a spectrum of optical performances, size/weight considerations, and operational features — often requiring a pragmatic balance between these three central specifications — Figure 4. Long focal ranges combined with a wide aperture — as required for sports coverage — might militate against achievement of the highest optical performance. Lenses intended for portraiture might assign the top priority to overall optical performance specifications — perhaps at a cost of some limit to aperture and maybe size and weight. The variations in diverse shooting requirements are endless.

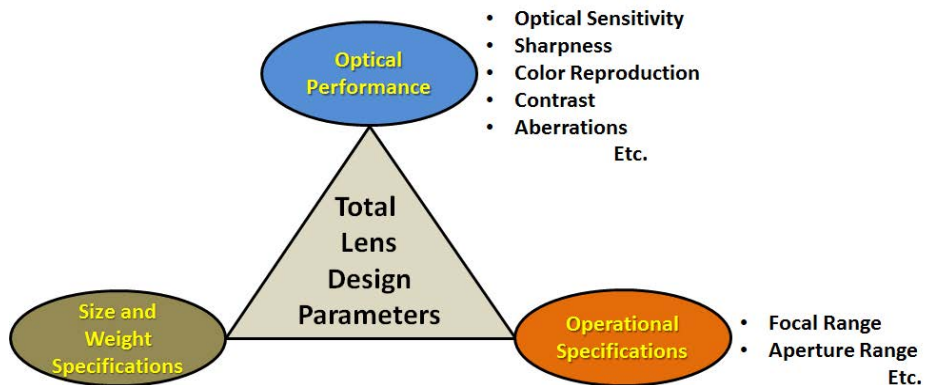

**Figure 4** *The totality of lens design entails many parameters that bear upon three key criteria*

If the area of the triangle in Figure 4 reflects all of the optical, optomechanical, and electronic design parameters available to the lens designers, then maximizing that area offers greater options in favoring certain specifications, or alternatively, optimizing the balance between the three core specifications.

In that context, seeking the ideal lens for a given shooting application must envisage broadening flexibilities in optical and system developments according to the following:

1. Higher Optical Performance — to accommodate multiple future enhancements in camera performance
2. Increased optical speed — for specific lenses
3. Enhanced Operational Specifications — such as focal length ranges, maximum aperture, and their controls
4. Meeting demands in Size and Weight Specifications — which can be critically important to certain forms of shooting

The ideal lens for a given shooting application typically seeks optimization of one of the three specifications, generally accompanied by a desire to also elevate the priority of a second of these specifications — as suggested in Figure 5. Note that the area of the triangle remains constant — but the increased number of design parameters offers new flexibilities to achieve these higher design goals. For other lens designs, there are also more options available to support a more favorable balance between the three specifications.

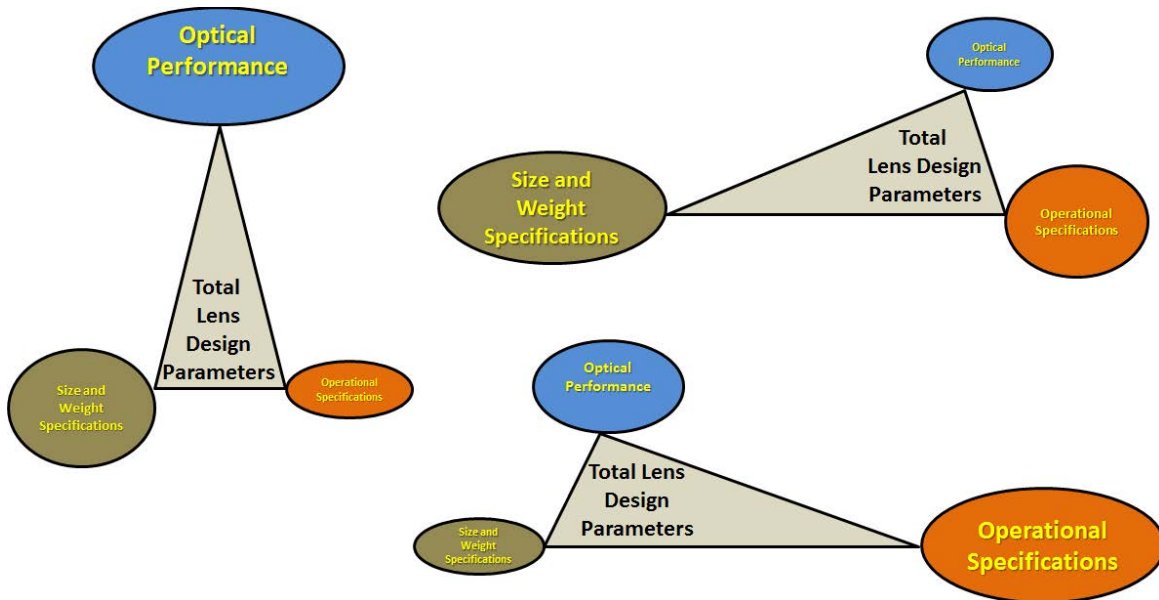
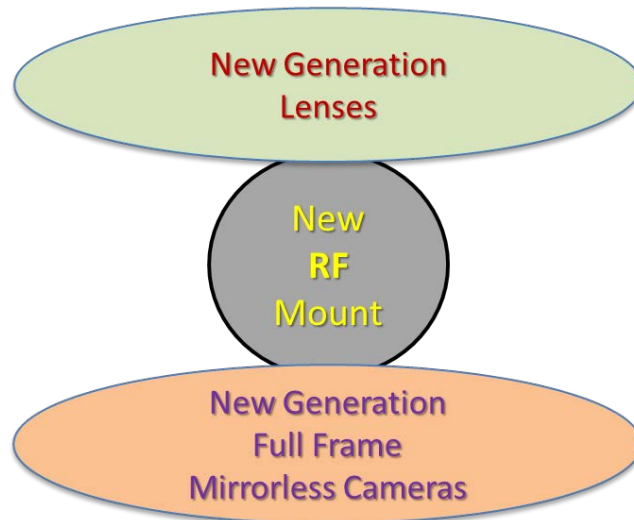

**Figure 5** *Illustrating the diversity in lens designs required to meet contemporary imaging needs*

Over the decades the Canon EOS EF lens designs have supported reasonable flexibility in managing often conflicting requirements — primarily because of the large 54 mm mount. On the other hand, the longer 44mm flange back distance (distance from a reference point on the lens mount to the image sensor )has hampered certain degrees of freedom in some lens designs. That space between the final lens element and the image sensor (especially in the case of the large full frame image sensor) is invaluable to achieving optimization of the projected image performance. Accordingly, central to achieving extensions in lens design options is a radical redesign of the lens mount.

## 7.0 KEY TO NEW LENS GENERATION — NEW LENS MOUNT

Central to the effective implementation of the strategy to extend the potential of the EOS system for the future is a new lens mount. Canon has developed a mount that holds high promise of sustaining far more flexible lens designs over the long term — the new RF mount.

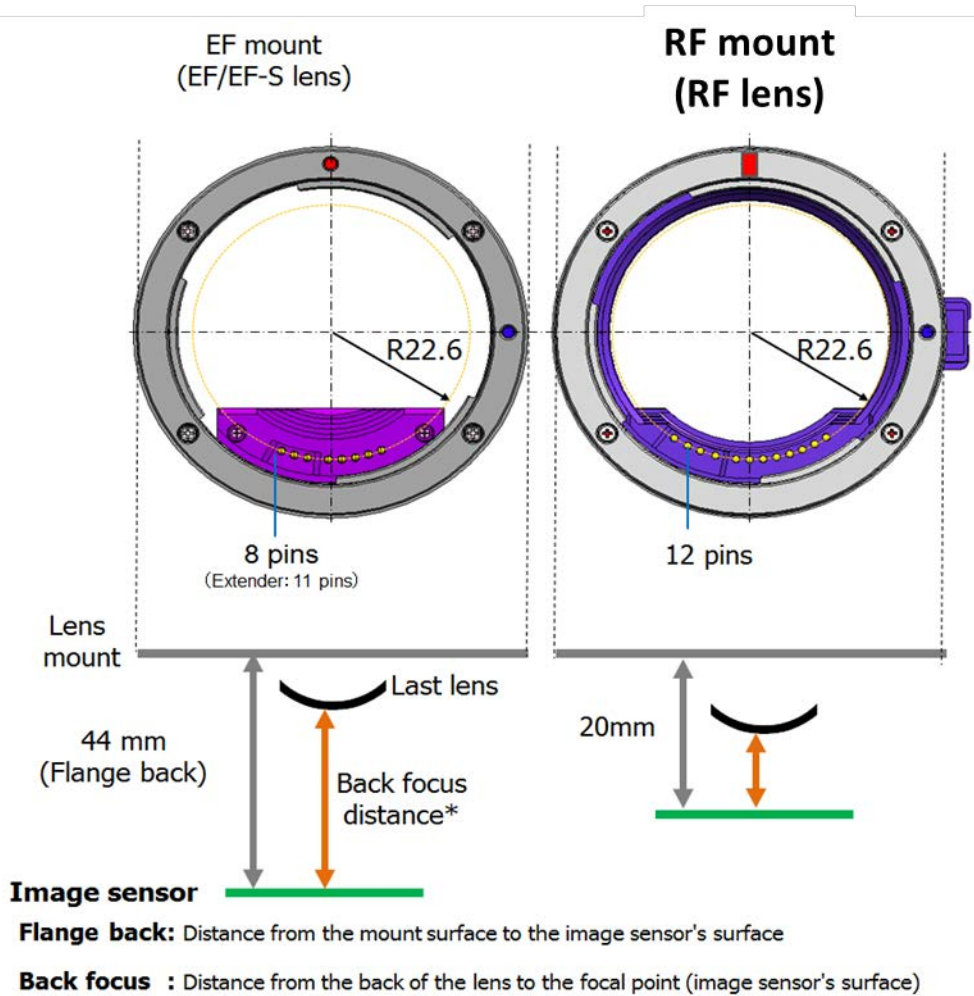

**Figure 6** *The new lens mount is designed to empower new flexibilities in lens design and a new generation of mirrorless cameras*

### Considerations that guided the new lens mount design:

1. Totally new mount — but one that retains the large 54 mm inner diameter of the EF mount
2. Accommodate current Canon EOS image sensor sizes up to Full Frame 36mm x 24mm
3. Leverage the shorter 20mm flange back distance of the Mirrorless (ML) system to support new optical designs
4. Significant elevation of the electronic communication in the new interchangeable lens-camera system — increasing the number of contact pins from eight (current EF) to twelve
5. Accommodation of existing (and new) EF lenses — with virtually no performance compromises

## 8.0 DETAILS OF THE NEW CANON RF MOUNT

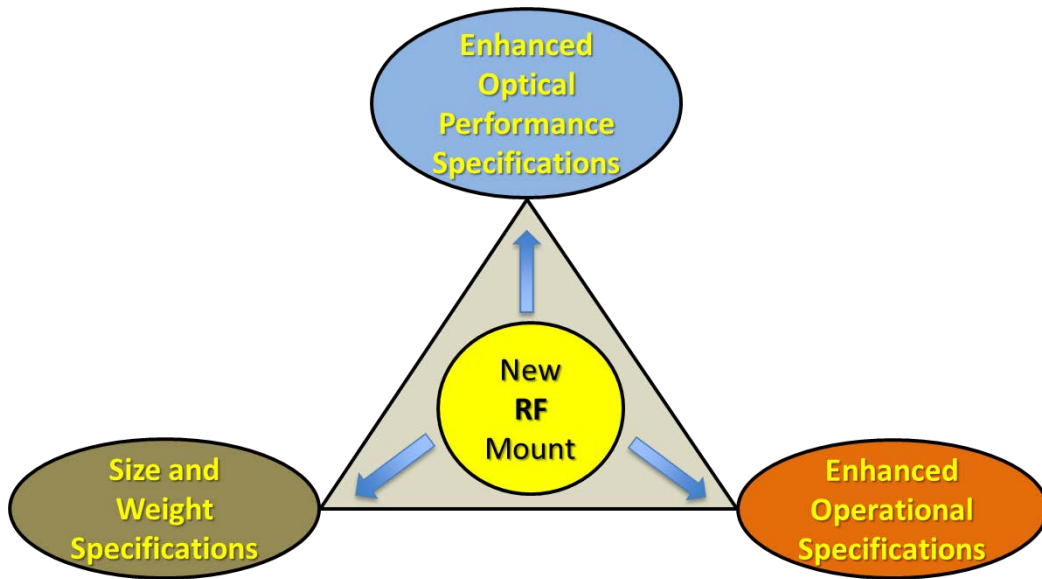

**Figure 7** Showing new RF mount (on the right) side by side with the existing EF mount (on the left)

RF mount is a new mount that maintains the advantages of a fully electronic large-diameter EF mounts while additionally offering an optimal diameter, flange back, and back focus to more fully capitalize on optical characteristics of a full-frame mirrorless systems.

Like the EF mount, a 3-tab bayonet mount is used in the RF mount. However, to prevent incorrect attachment, bayonet tabs are in different positions than they are on the EF mounts. For this reason, EF lenses cannot be attached directly. In use, the new RF mount also resembles existing EF mounts. Lenses are rotated to an angle of 60° for attachment or removal, and the lens lock pin is in the same position as on an EF mount (at the 3 o'clock position, as viewed from the front of the camera), with the same amount of protrusion and movement.

The reduction from a 44mm flange back distance in the EF mount system to the 20 mm of the new RF mount system opens important additional degrees of freedom in lens designs. The pivotal innovation offered by this short distance, combined with the large 54 mm diameter RF mount — is the freedom to deploy large diameter optical elements at the very rear of the lens and closer to the large image sensor. This adds new optimization capabilities to the lens-camera imaging interface.



**Figure 8**     *The new lens mount significantly expands the degrees of freedom in mobilizing the multiple variables in high-end lens design to implement a far greater range of zoom and prime lenses*

The new RF mount makes possible greater lens design flexibilities:

1. Large diameter rear lens elements that are much closer to the full frame image sensor — enhancing overall optical performance (in particular, tighter control over optical aberrations at image extremities)
2. Lenses having the same specifications for focal length and maximum aperture as current EF mount lenses—but *having significantly higher image quality* — within the same size and weight
3. High optical performance, large aperture (F1.2) prime lenses for full frame cameras
4. Zoom lenses of higher brightness with constant aperture over their focal ranges — while still modest in size and weight

The following section is intended to convey the critical importance of back focus distance and rear lens diameter on the overall optical performance of a given lens.

## 9.0 THE CHALLENGE OF MANAGING LENS ABERRATIONS

Optical aberrations are an inescapable reality of each and every element within all lenses. The well-known Seidel monochromatic aberrations are image defects associated with the fundamental behavior of light rays—of all wavelengths — passing through a lens element. These monochromatic aberrations include *spherical aberration*, *coma*, *astigmatism*, *curvature of field* and *geometric distortion*. Collectively, they are often termed the “defocusing distortions” because they cumulatively conspire to impair image sharpness (especially as a lens iris setting approaches maximum aperture).

In addition to monochromatic aberrations, there are additional aberrations associated with colored light that are wavelength-dependent. Different wavelengths of light encounter a different index of refraction within a given optical material, referred to as dispersion. These are technically described by two aberrations: (a) *Longitudinal chromatic aberration* (different focus plane for constituent colors) that produce an unwanted colored flare; and (b) *Lateral chromatic aberration* (because magnification of different wavelength rays vary they cause an associated variation in the lateral magnification that producing an effective color misregistration in the recorded video or still image).

Light rays passing through the center of a multi-element lens will exhibit a modest degree of these aberrations. However, as light rays from the extremities of a framed scene enter the lens at increasing angles and are ultimately focused on the extremities of the CMOS image sensor image plane, the aberrations can all rapidly increase. The more acute the angle of those rays being projected on to the sensor — the greater the level of aberrations. For a large image sensor like Full Frame this poses a particular challenge to the lens — especially when the corners of the image contain high detail.

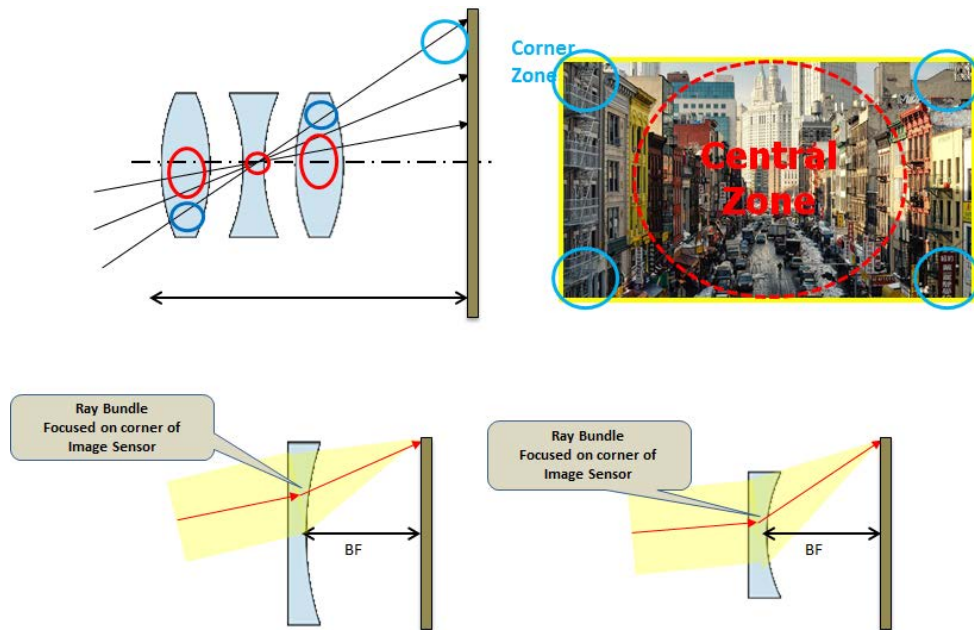

**Figure 9** Concept of a hypothetical lens imaging a highly detailed scene — and the importance of the back focus distance and rear lens diameter on the angle of a ray bundle projecting onto the corners of the image sensor

Two key dimensions play a significant role in the quality of the final image projected on to the image sensor — they are the back focus distance and the diameter of the final lens element. Figure 9 is a simplistic illustration of their cumulative effect on the angle of the ray bundle landing on the extremities of the image sensor. The colored circles identify ray bundles affecting image performance in the image central zone (red) and in the image extremities (blue).

As the refractive index, or “bending” power of the lens increases, various aberrations tend to increase easily.

If the rear lens is larger, ray bundles can be projected more gently to the larger image sensor and suppression of the occurrence of various aberrations can be made. On the other hand, the smaller the rear lens is, it is necessary that the refraction of the ray have a more acute angle to the larger image sensor by stronger refractive power of the lens, which can lead to more various aberrations.

The criticality of the back focus distance is simplistically illustrated in Figure 10. The top image simulates a lens having a long back focus distance — such as exists in the current Canon EOS EF lens system. Many design strategies are mobilized for the many different types of zoom and prime lenses in this family of lenses to counteract the effect of aberrations. One key strategy is to use a large lens element in the front of the lens system to more independently and gently manage the degree of the angle of the emerging light ray bundle projected on to the image sensor. This generally will extend the length of the overall optical system.

If, however, the back focus distance could be shortened, this then opens up space to move the final lens element closer to the image sensor — and *if this element is made large* then an equivalent control for aberrations of the ray bundle projected on to the corner of the image sensor can be made — as shown in the lower image in Figure 10.

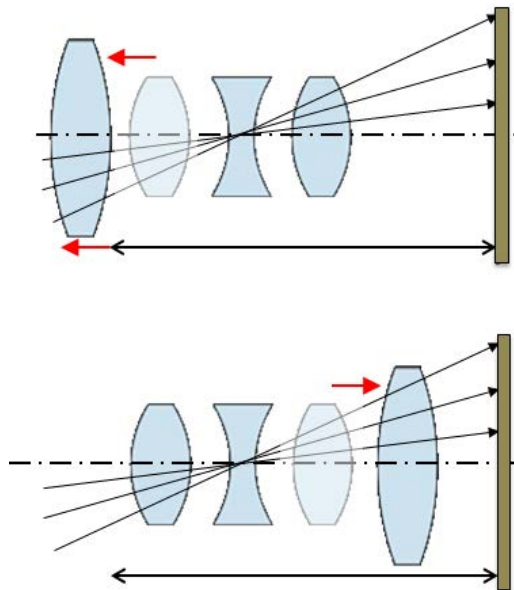

**Figure 10** Showing two alternatives in lens design to independently and gently control aberrations of the ray bundle projected on to the corner of the image sensor

## 10.0 NEW CONCEPTS UNDERLYING RF LENSES

### 10.1 New Feature Unique to RF Lenses

The new RF lenses represent a quite radical step forward in lens designs that anticipate the future imaging needs of an increasingly sophisticated end user.

#### 10.1.1 Control Ring

A significant new innovation is incorporated into the design of these lenses — a special knurled control ring, which in the initial RF lens embodiments is positioned at the very front of the lens — before the focusing control ring, as shown in Figure 11. It capitalizes on the augmented electronic communication between lens and camera that is central to the new lens design. The purpose of the ring is to facilitate intuitive and flexible access to adjustment of Aperture value / Shutter speed / ISO and Exposure Compensation. The particular function selection is performed in-camera in the Custom Function menu. In the new lenses described in this paper, as the ring is rotated it clicks (different number of clicks per revolution for different RF lenses) which serves to provide a sensory cue while the photographer is looking through the viewfinder. The direction of rotation can be set to suit user preference. And, users have a choice of whether control ring rotation actually changes exposure only when the shutter button is pressed half-way (to minimize risk of inadvertent changes), or to have any movement directly impact exposure (with no need to first hold the shutter button half-way down).



**Figure 11** *Showing the new Control Ring that extends operational flexibilities for the photographer*

A new microprocessor within the lens has improved processing capability together with lower power consumption and high-speed communication. The increased capacity of the built-in memory allows more data to be stored, enabling highly accurate lens control and image correction. This is especially important for the Digital Lens Optimizer feature of the RF system.

#### 10.1.2 Aperture Blade Control

The new family of RF lenses incorporates an important new feature that automatically closes the aperture blades one or two steps wider than the smallest position upon power close down. This helps protect the camera image sensor and shutter blades from damaging high intensity light sources.

### **10.1.3 Focus Ring Rotation Direction Change**

The RF lenses all incorporate an ability to choose the direction of rotation of the manual focus control. In place of a direct mechanical connection from focus control ring to the actual focusing optics, through a threaded, all mechanical helicoid, the system uses a focus ring connected to a series of many very fine, electronic contacts. There's no direct, mechanical connection at all to the group(s) of elements that move the focusing element. Rotating the focus ring sends a series of very specific, fine signals to these contacts. These are converted into signals to the same focus motor (USM, Nano USM, etc.) that's used for autofocus. The motor now drives the lens to change focus.

Inherent to this system there is a custom function to change Manual Focus direction, which can be an invaluable asset to users transitioning to Canon from competitive systems. This also benefit users who utilize a follow focus system (external gears and a knob to control focus) .

### **10.1.4 Enhanced Electronic Communication between Lens and Camera**

The new RF mount uses 12 contacts instead of the 8 contacts of the EF lenses for lens-camera communication. New communication protocols and dedicated communication channels are incorporated — which support large data transfers at very high speeds compared to current EF system. The new RF system design anticipates ongoing innovations in future cameras as well as lenses. Even with these changes, full support and compatibility for existing Canon EF and EF-S lenses remain.

## **11.0 INTRODUCTORY FAMILY OF CANON RF LENSES**

This white paper will outline four lenses that constitute the introductory phase of the new RF system:

- 10.1 RF28-70mm F2 L USM
- 10.2 RF50mm F1.2 L USM
- 10.3 RF24-105mm F4 L IS USM
- 10.4 RF35mm F1.8 MACRO IS STM

## 11.1 RF28-70mm F2 L USM

RF28-70 F2 L USM is a large-diameter, standard L zoom lens with a bright F2.0 constant aperture across the entire zoom range — the new 28-70mm F2. The lens is intended for professional photographers, high-end amateurs, and low-light moviemaking. It embodies high-speed auto focus functionality, and a Control Ring for functional assignment of exposure controls.



**Figure 12** *The new RF28-70 F2 L USM — a compact 28-70mm F2.0 zoom lens has high overall optical performance and excellent operational empowerments*

The lens is comprised of nineteen elements in thirteen groups. The large diameter mount and the short back focus are used to particular advantage to gain the higher brightness of F2.0. These two factors mean the front section of the lens can be physically much smaller than conventional EF lens architecture. The strategic disposition of four aspheric lens elements (shown in light green) in Figure 13 helps to minimize astigmatism, spherical aberration and geometric distortion, while the two UD and one Super UD elements (dark green) help curtail the longitudinal and lateral chromatic aberrations.

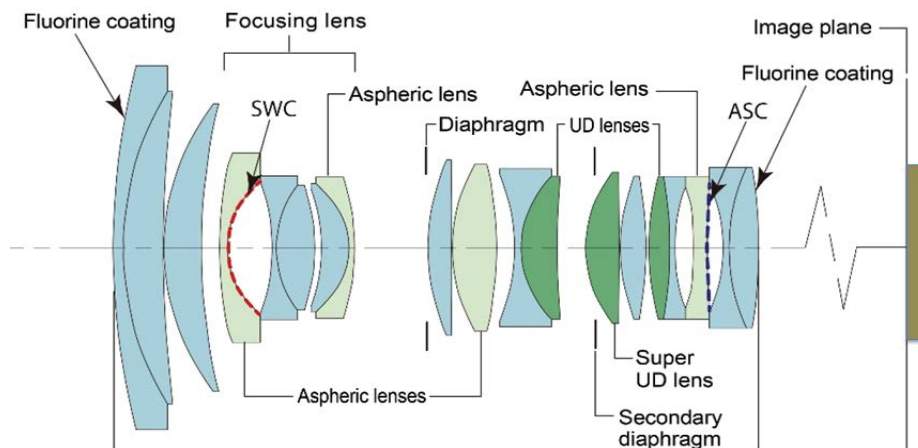

**Figure 13** *There are thirteen groups made up of a total of nineteen lens elements in the RF28-70mm F2 L USM lens*

The new RF mount made possible a zoom lens having an ultra-large diameter and a constant F2.0 aperture across the entire zoom range. The F2.0 maximum aperture creates an excellent creative bokeh.

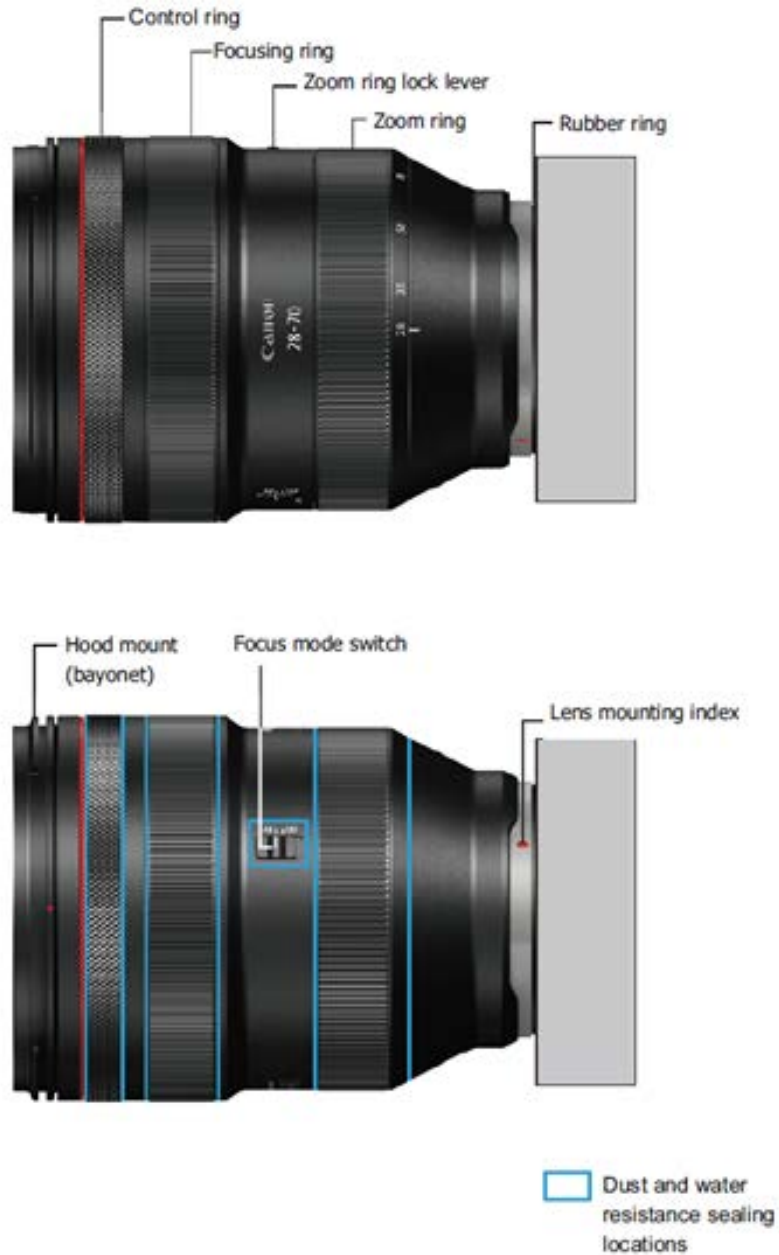
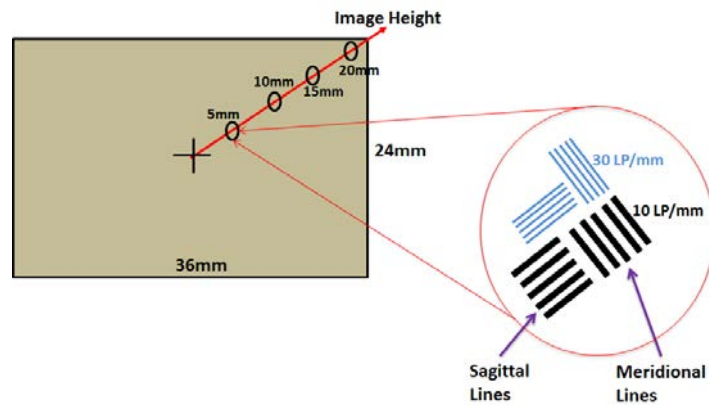

**Figure 14** *Showing the operational controls on the RF28-70mm F2 L USM lens*

This remarkable zoom lens is represents a significant step forward in terms of the F2.0 constant aperture, generous zoom range, and a size and weight that would not have been possible in an EF lens. It is ideal for handheld shooting.

### 11.1.1 MTF Characteristics of the RF28-70mm F2 L USM Lens

The MTF curves in Figure 15 show the behavior of this lens measured at four distances from the image center. Two spatial frequencies are used — one, at the low 10 line pairs per millimeter (LP/mm) which is an important measure of the contrast of the lens, and the second is at a higher 30 LP/mm which indicates resolving power. Two separate measurements are made for each at right angles to each other. The term “image height” refers to how far toward any of the four corners of the image a measurement is taken as shown in the figure below.



| Aperture Setting    | Max Relative Aperture |            |
|---------------------|-----------------------|------------|
| Spatial Frequencies | Sagittal              | Meridional |
| 10 Lines / mm       | —                     | .....      |
| 30 Lines / mm       | —                     | .....      |

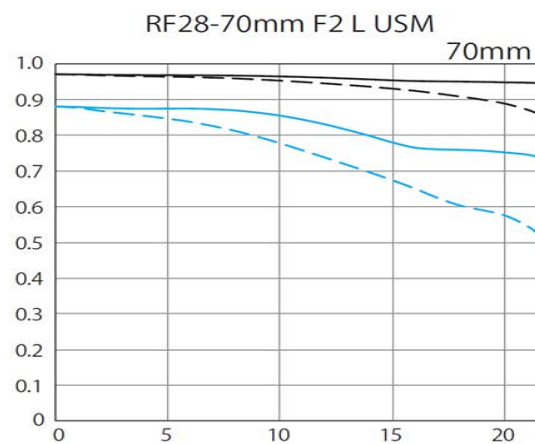
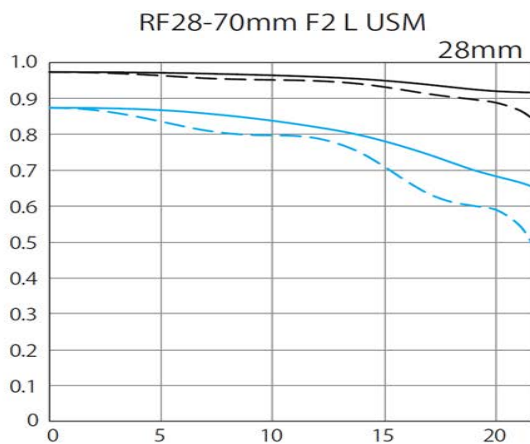
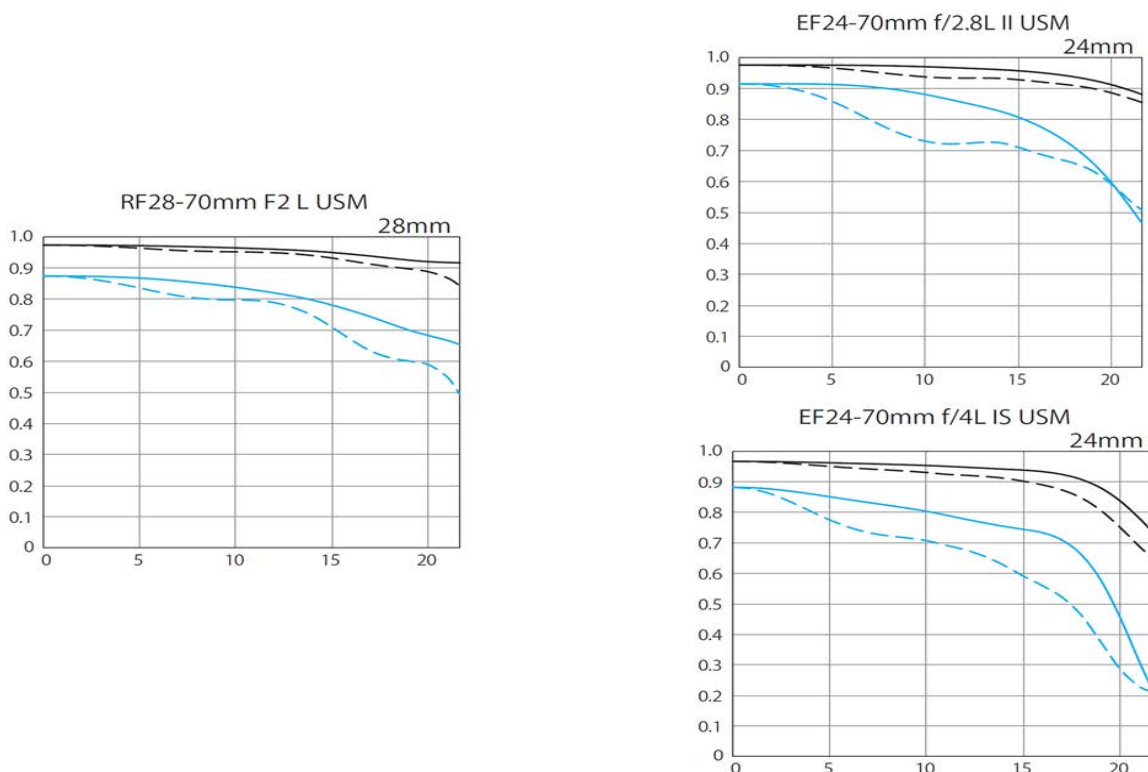

**Figure 15** MTF characteristics of the RF28-70mm F2 L USM — the wide aperture setting on the left and telephoto on right

## 11.1.2 MTF of RF28-70mm F2 L USM and Equivalent EF Zooms

Figure 16 shows the MTF curves for the new EF28-70mm F2 L USM on the right compared with those of two established EF zoom lenses — with all three lenses set at maximum aperture. Of special note are the following:

1. 10 Lp/mm Sagittal of the new F2 lens is very close to that of the EF24-70mm f/2.8L II USM lens (slightly better at maximum image height) and is much higher than the EF24-70mm f/4L IS USM lens at max height
2. 10 Lp/mm Meridional approximates the performance of EF24-70mm f/2.8L II USM at the image extremity, but it is much better than the EF24-70mm f/4L IS USM lens at maximum image height
3. 30 Lp/mm Sagittal behavior is considerably better than the EF24-70mm f/2.8L II USM at maximum image height and is far higher than that of the EF24-70mm f/4L IS USM
4. 30 Lp/mm Meridional curve for the RF28-70mm F2 L USM is higher from image center to an image height of 15mm than both EF zoom lenses and is equivalent to EF24-70mm f/2.8L II USM at image extremity — but much better than EF24-70mm f/4L IS USM at the extremity



**Figure 16** Comparative MTF Behavior of RF28-70mm F2 L USM versus equivalent EF zoom lenses at the wide angle setting (all lenses set to maximum aperture)

Figure 17 shows the MTF curves for the telephoto end of all three zoom lenses.

1. 10 Lp/mm Sagittal is slightly higher than both EF lenses at the far corners of the image
2. 10 Lp/mm Meridional is essentially equivalent to that of the EF24-70mm f/2.8L II USM but is higher than that of EF24-70mm f/4L IS USM
3. 30 Lp/mm Sagittal is higher than both EF lenses at the 22 mm height
4. 30 Lp/mm Meridional is essentially equivalent to that of the EF24-70mm f/2.8L II USM out to 15mm height — but is higher at the 22mm extremity
5. 30 Lp/mm Meridional is higher than that of the EF24-70mm f/4L IS USM out to 15mm away from image center — and is significantly higher at the 22mm extremity

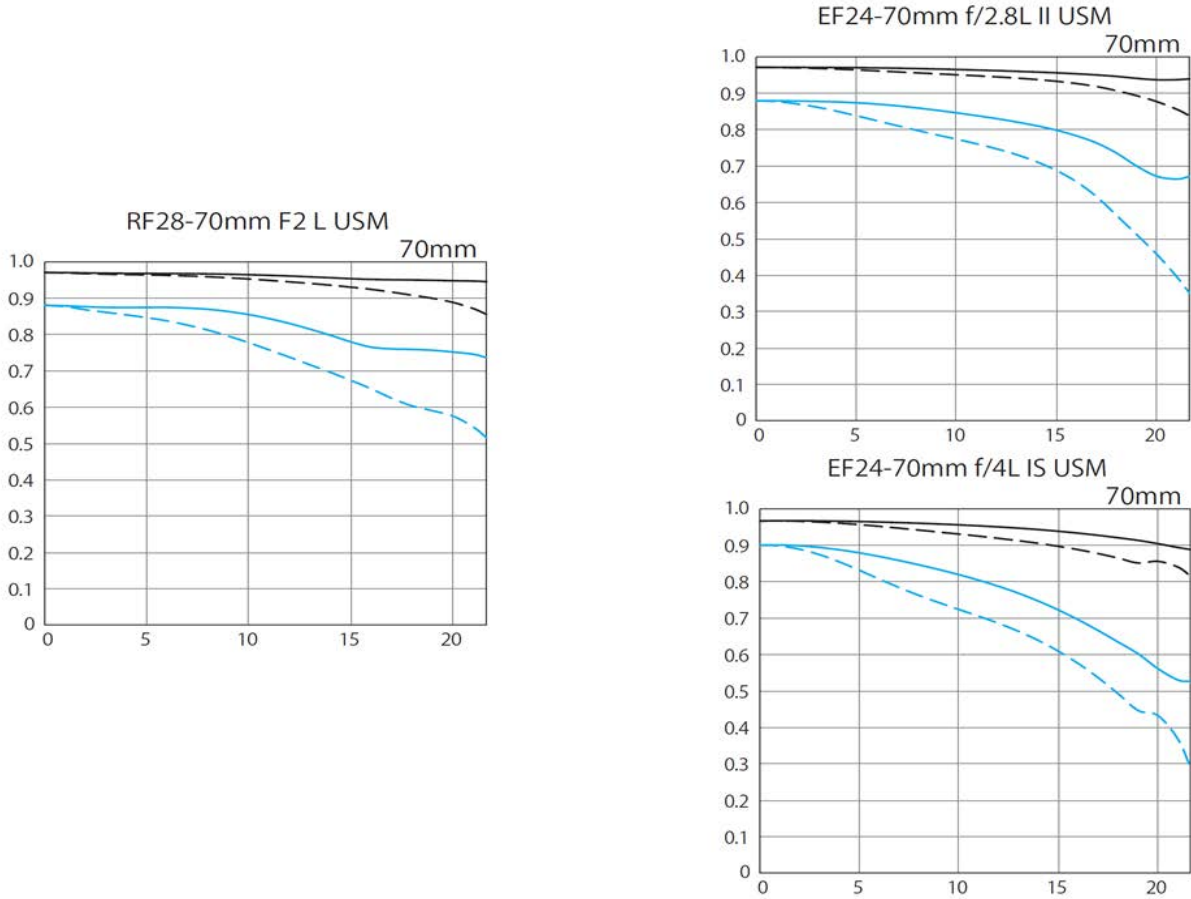

**Figure 17** Comparative MTF Behavior of RF28-70mm F2 L USM versus equivalent EF zoom lenses at the telephoto end of their respective zoom ranges

## 11.2 RF50mm F1.2 L USM

This is a large diameter standard single-focus lens employing the new standard RF mount. At its maximum aperture of F1.2 the lens maintains high sharpness at image center with well controlled falloff of MTF toward the image extremities. The lens is designed to extend the creative photo expressiveness for professional photographers and high-end amateurs.



**Figure 18** The new RF50mm F1.2 L USM features high overall optical performance and innovative operational functionalities

The lens is a totally new optical design, comprised of fifteen elements in nine groups. The rear elements capitalize on the short flange back of the EOS R system — their large size contributing to the high optical performance. The first eleven elements constitute the focusing optics. The lens has a minimum focal distance of 40 cm (15.7 inches) and maximum magnification is 0.19x.

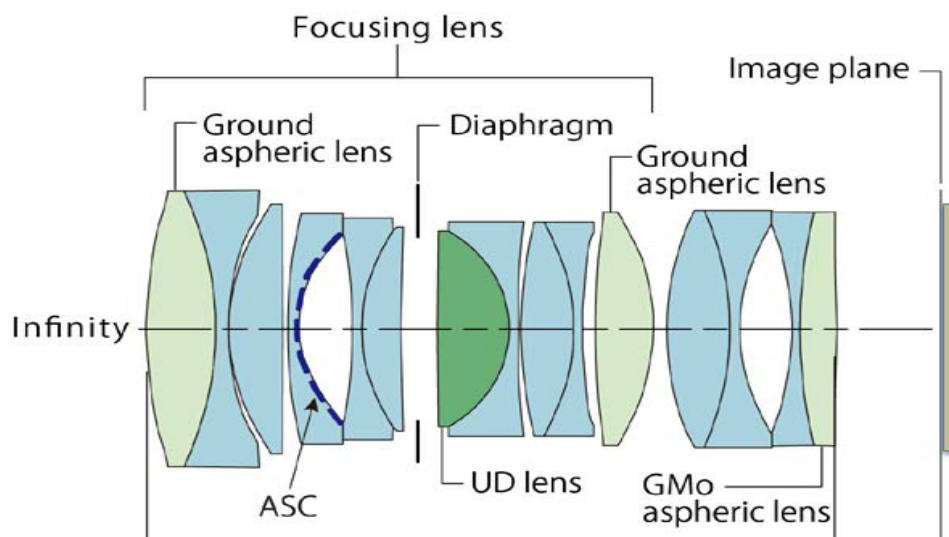

**Figure 19** Showing the nine groups made up of a total of fifteen lens elements within the RF50mm F1.2 L USM lens

The lens deploys three high-refraction aspheric elements — shown in green in Figure 19. Chromatic aberrations are minimized using the UD element (dark green).

Flare and ghosting are particularly well controlled using Canon’s Super Spectra Coatings — with the Air Sphere Coating (ASC) technology on one critically positioned lens element shown in Figure 19. Air Sphere Coating is an anti-reflection technology that combines the existing vapor-deposited multi-layer coatings with an ultra-low refractive index outermost layer. ASC significantly reduces flare and ghosting that cannot be prevented with conventional vapor-deposited multi-layer coatings, improving anti-reflection performance.

This lens is a striking example of the powerful new flexibility offered by the new RF mount in achieving the F1.2 brightness in a compact lens. To achieve this level of optical quality in an F1.2 design with the standard EF mount would have entailed a significantly larger lens. The lens enables close-ups from a closest focusing distance of 1.31 feet and produces beautiful bokeh from a circular aperture with a 10-blade iris.

The focusing actuator is a ring USM (ultrasonic motor). The lens has a 10-blade aperture actuated by EMD (Electro Magnetic Diaphragm) which supports beautiful rendering of out-of-focus backgrounds.

The front filter size is 77 mm.

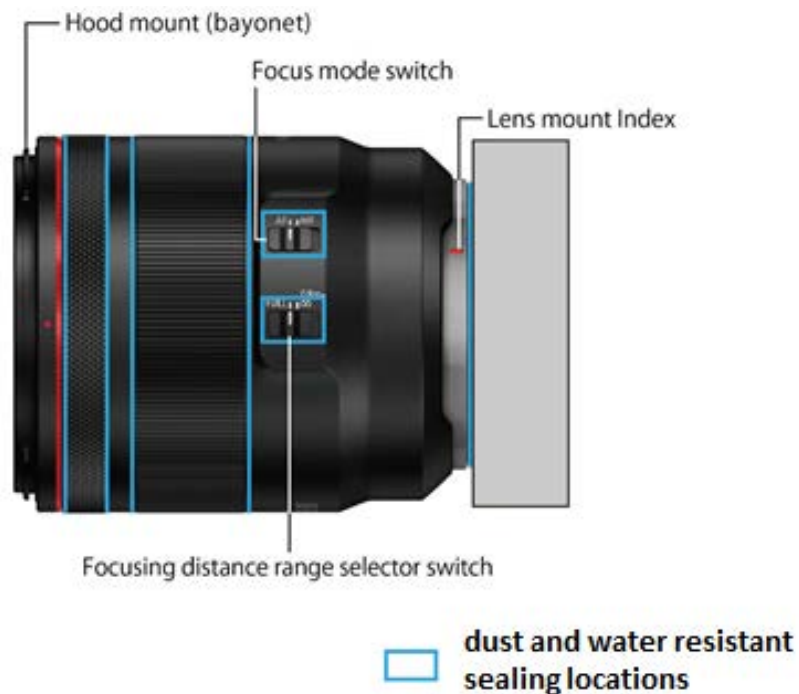

**Figure 20** *Showing the Focus Mode and Focus Distance Range Selector switches while also outlining where dust and water sealing design precautions have been implemented*

## 11.2.1 MTF Characteristics of the RF50mm F1.2 L USM lens compared to EF Lenses

Figure 21 shows the MTF characteristics of the RF50mm F1.2 L USM lens at the maximum relative aperture setting of F1.2.

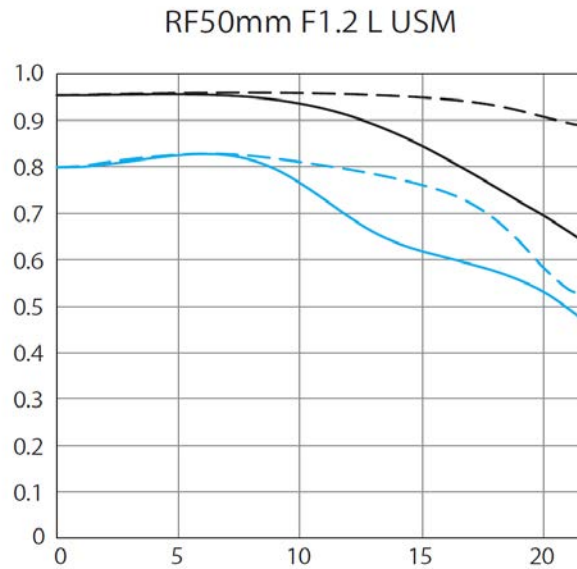

**Figure 21** The 10 and 30 Lp/mm MTF curves for RF50mm F1.2 L USM

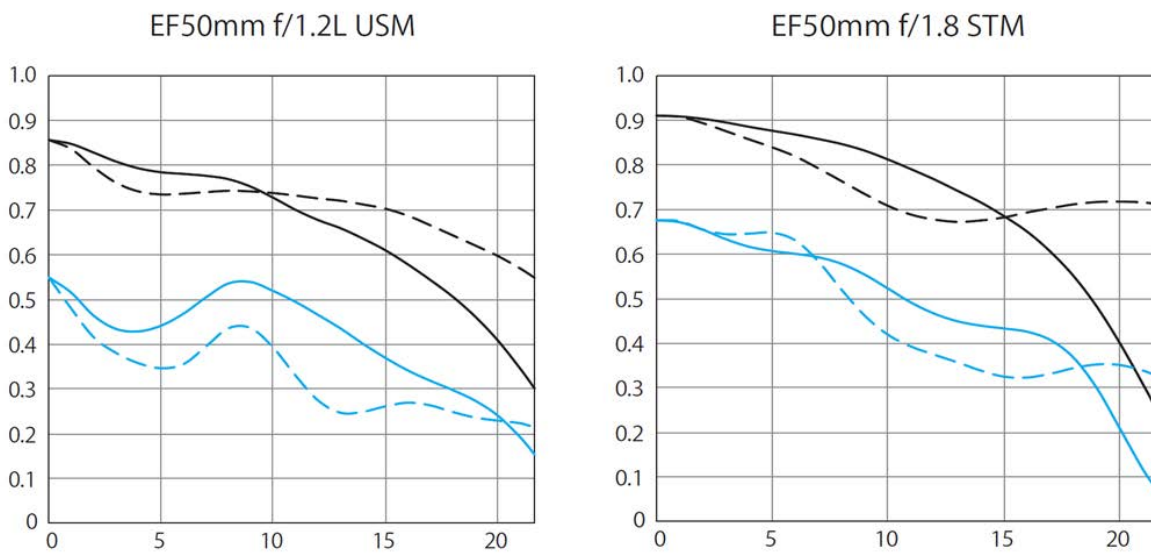
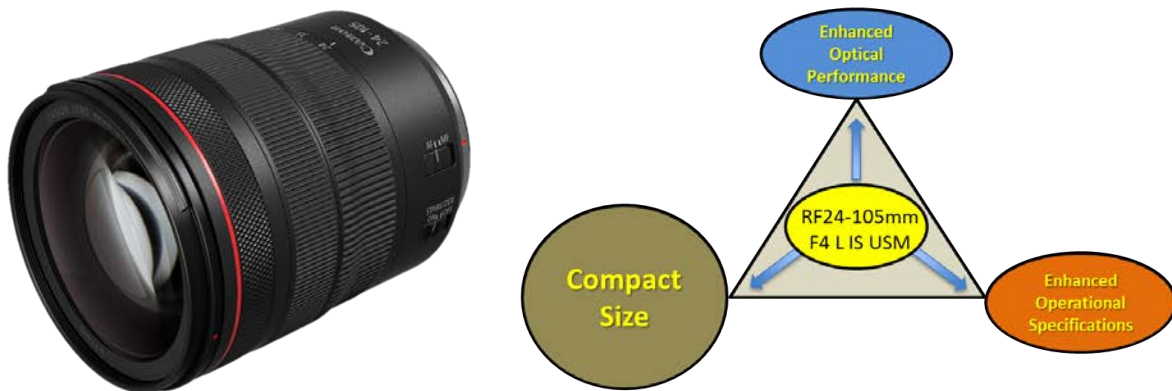

**Figure 22** Comparing the MTF characteristics of the RF50mm F1.2 L USM lens with two 50mm EF lenses

1. 10 Lp/mm Sagittal of the RF50mm F1.2 L USM lens maintains a significantly higher MTF across the total image height compared to both EF lenses (and especially compared to the EF50mm f/1.2L USM)
2. 10 Lp/mm Meridional exhibits an excellent MTF characteristic compared to both EF lenses
3. 30 Lp/mm Sagittal exhibits a higher and more controlled MTF across the total image height than the two EF lenses
4. 30 Lp/mm Meridional curve for RF50mm F1.2 L USM lens also shows an excellent characteristic that is superior to that of both EF lenses

### 11.3 RF24-105mm F4 L IS USM

RF24-105mm F4 L IS USM is a medium-diameter standard zoom lens with an F4.0 constant aperture over the entire 24-105mm focal range. Its minimum aperture is F22. The lens is intended for professional photographers, high-end amateurs, and low-budget moviemaking. It embodies an enhanced image stabilization system, high-speed auto focus functionality, and the innovative new knurled control ring for functional assignment of exposure controls.



**Figure 23** *The new RF24-105 F4 L IS USM has high operational functionality and impressive optical performance in an unusually compact size*

Even with the built-in image stabilization system the size and weight have been minimized to allow easy hand-held shooting. Minimum focusing distance is 0.45m (1.48 feet). The lens is comprised of eighteen elements in fourteen groups. This is a particularly interesting example of unusually large diameter rear elements capitalizing on the short flange back of the RF system — with this combination contributing to the high optical performance of the image projected onto a large Full Frame sensor.

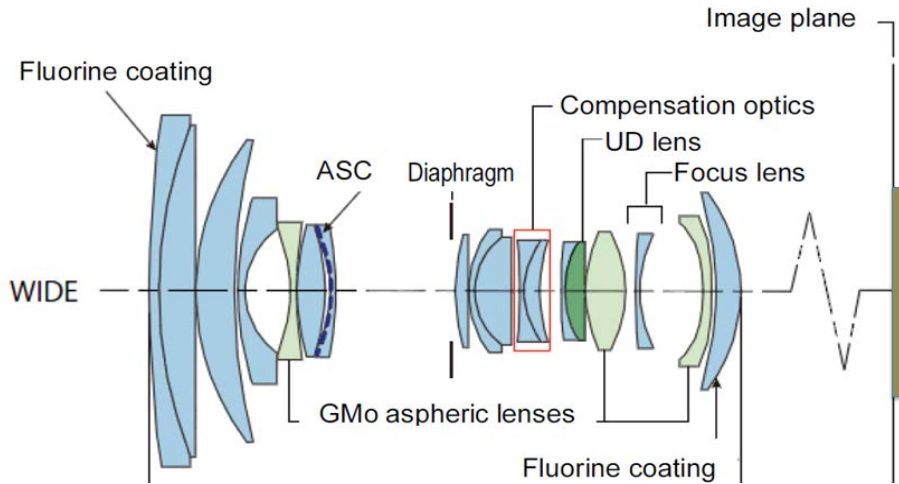

**Figure 24** Showing the fourteen groups made up of a total of eighteen lens elements in the RF24-105mm F4 L IS USM lens

Strategic disposition of three aspheric lens elements (shown in light green in Figure 24 helps correct for astigmatism, spherical aberration, and geometric distortion. The UD lens element shown in dark green helps minimize both lateral and longitudinal chromatic aberrations. The Compensation Optics group in the center is the lens element group which performs the image stabilization correction.

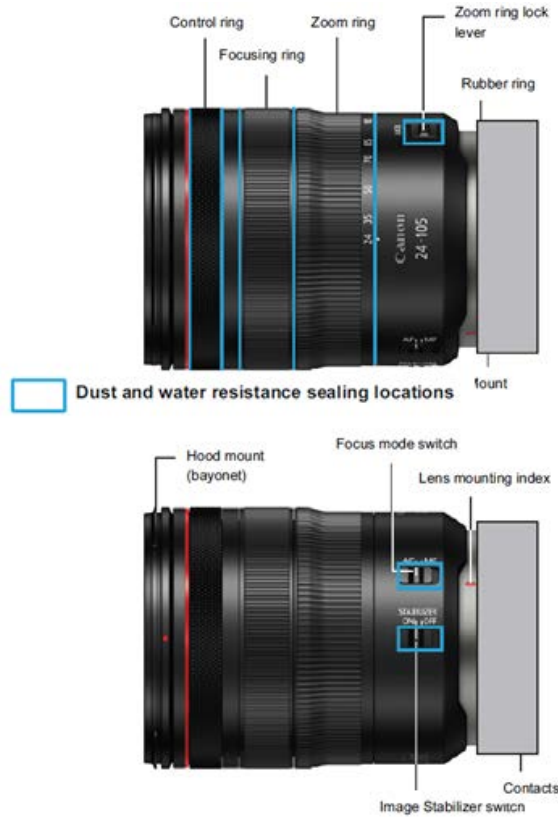

**Figure 25** Showing the Zoom, Focusing, and Control rings and the various mode switches

Because the focusing element (“focus lens” in Figure 24 above) is small and lightweight the focusing actuator deploys a Nano USM (new Thin-type). This motor uses the basic Ultrasonic principle, of extremely controlled, fine vibrations produced by running current through a specific metal device. In this case, the "device" looks almost like a tiny metal bandage, with little projecting nubs on either side — Figure 26. These in turn contact a sliding surface, and vibrations are transformed into linear movement, and a lens element guided by a control bar moves fore or aft to drive focus in either direction.

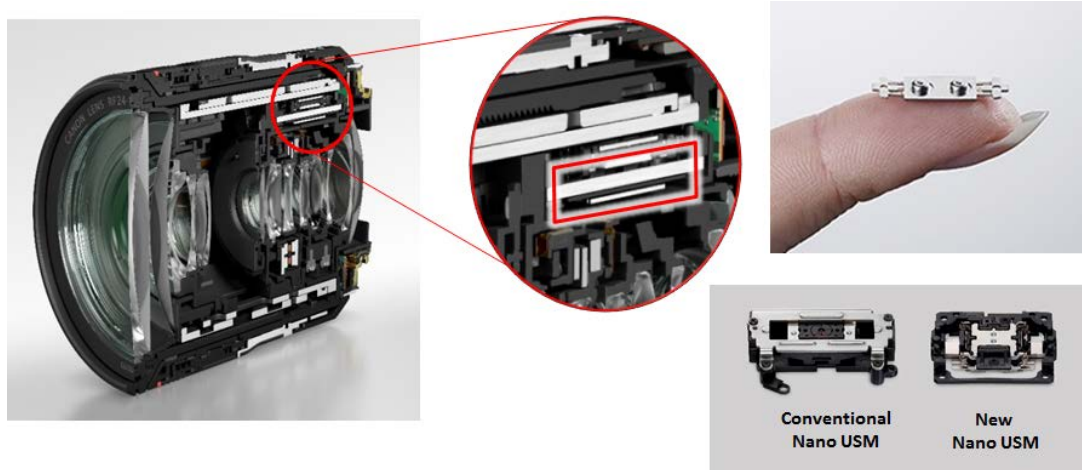

**Figure 26** Showing the Nano USM used to actuate the focusing element in the new RF24-105mm F4 L IS USM zoom lens

The Nano USM is very quick and quiet and is particularly well-suited to stop-and-start operation that's quite common in video shooting. It also helps ensure much smoother AF during video acquisition.

### 11.3.1 MTF Characteristics of the RF24-105mm F4 L IS USM Zoom Lens

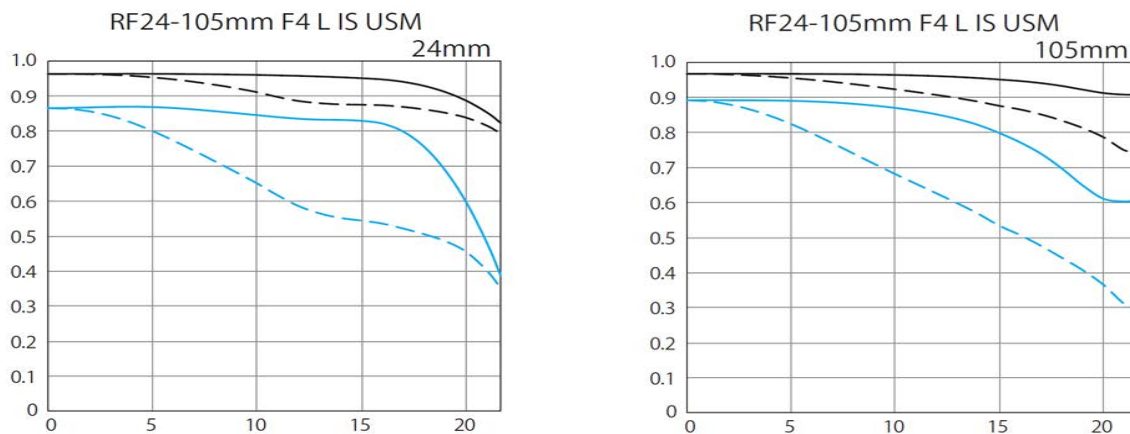

**Figure 27** MTF characteristics of the RF24-105mm F4 L IS USM lens at both the wide end and the telephoto end

Figure 28 shows the MTF curves for the new RF24-105mm F4 L IS USM on the left compared with those of two established EF zoom lenses — for the wide end of their respective zoom ranges. Of special note are the following:

1. 10 Lp/mm Sagittal is slightly lower than that of the EF24-105mm f/4L IS II USM lens except at the extreme corners of the image
2. 10 Lp/mm Meridional maintains a higher MTF from image center to a height of 15mm than both EF lenses — and it approximates the performance of EF24-105mm f/4L IS II USM at the image extremity
3. 30 Lp/mm Sagittal behavior is slightly better out to an image height of 15mm than the EF24-105mm f/4L IS II USM but is higher than that of the EF24-105mm f/3.5-5.6 IS STM
4. At image extremity the RF24-105mm F4 L IS USM maintains a higher Sagittal MTF than both EF zooms
5. 30 Lp/mm Meridional curve for the RF24-105mm F4 L IS USM is higher from image center to an image height of 15mm than both EF zoom lenses and is equivalent to EF24-105mm f/4L IS II USM at image extremity — but much better than EF24-105mm f/3.5-5.6 IS STM

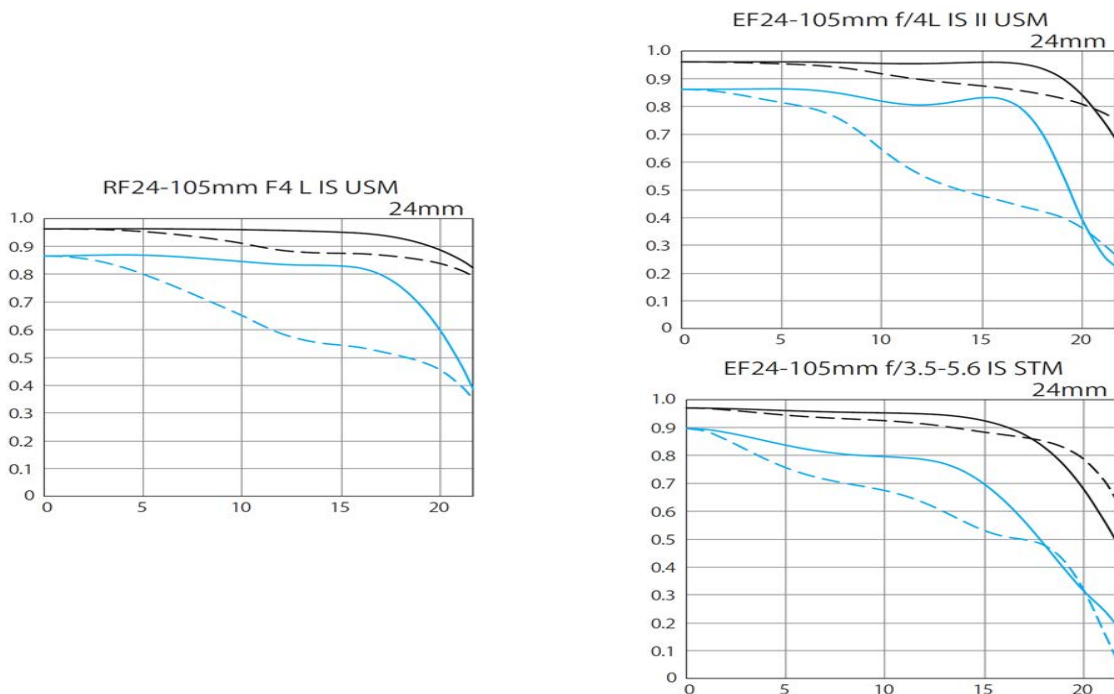

**Figure 28** Comparative MTF behavior of RF24-105mm F4 L IS USM versus equivalent EF zoom lenses at the wide angle setting

Figure 29 shows the MTF curves for the new RF24-105mm F4 L IS USM on the left compared with those of two established EF zoom lenses — for the wide end of their respective zoom ranges. Of special note are the following:

1. 10 Lp/mm Sagittal for RF24-105 F4 L IS USM is slightly lower across the image height than that of the EF24-105mm f/4L IS II USM except at maximum image height
2. 10 Lp/mm Meridional exhibits a lower MTF from image center to a height of 15mm than both EF lenses — and it approximates the performance of EF24-105mm f/3.5-5.6 IS STM at the image extremity
3. 30 Lp/mm Sagittal behavior is slightly higher at an image height of 15mm than both EF lenses
4. 30 Lp/mm Sagittal is slightly higher than both EF lenses out to 15mm height
5. 30 Lp/mm Meridional curve for RF24-105mm F4 L IS USM is very similar to both EF lenses out to 15mm image height and at image extremity is higher than EF24-105mm f/3.5-5.6 IS STM and slightly lower than EF24-105mm f/4L IS II USM

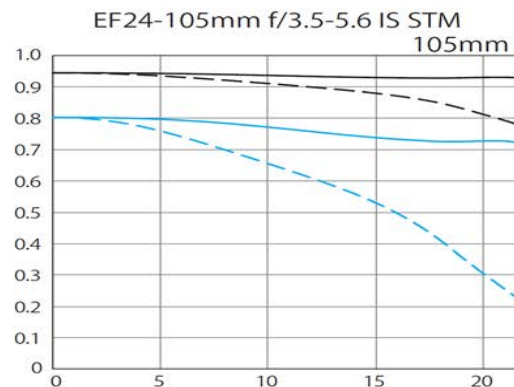
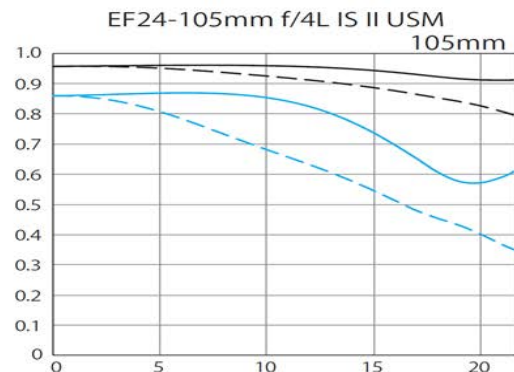
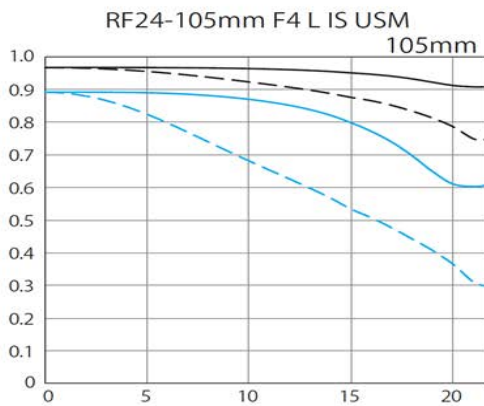

**Figure 29** Comparative MTF behavior of RF24-105mm F4 L IS USM versus equivalent EF zoom lenses at the wide angle setting

## 11.4 RF35mm F1.8 MACRO IS STM

RF35mm F1.8 MACRO IS STM is a wide angle macro lens employing the new standard RF mount having a maximum aperture of F1.8 and a 0.5x magnification. It has a minimum aperture of F22. This is a moderate wide-angle lens with a compact overall design, ideally suited to traditional candid street photography and low-light imaging. It combines beautifully with the smaller mirrorless camera as a lightweight, travel and location oriented lens for serious enthusiasts. In spite of its F1.8 maximum aperture, it doubles as a true macro lens, with ability to fill the frame with a subject as small as a business card at its nearest focus distance. Finally, it offers optical Image Stabilization, further enhancing its abilities in low-light situations.

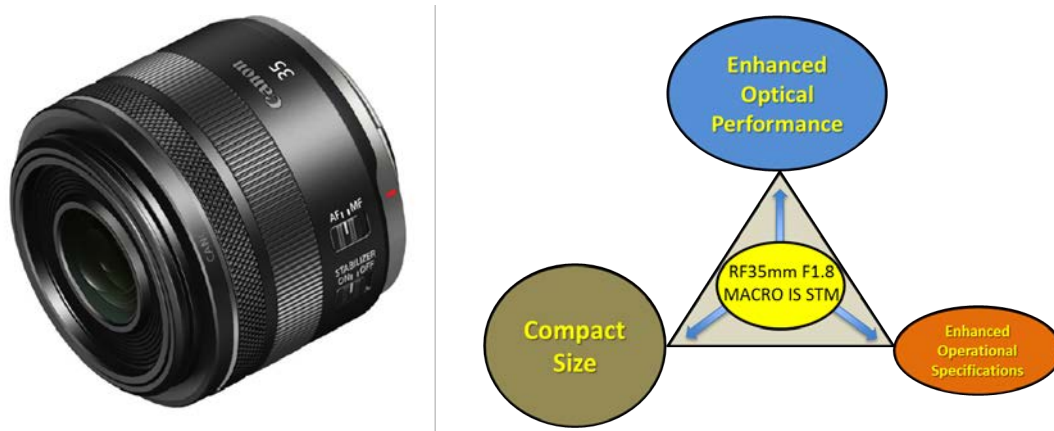

**Figure 30** The new wide angle RF lens — RF35mm F1.8 MACRO IS STM

The lens is comprised of eleven elements in nine groups — Figure 31. The rear elements capitalize on the short flange back of the RF system — having a particularly large diameter contributing to the high optical performance. The first nine elements constitute the focusing optics, and these are moved in tandem as focusing is carried out. An aspheric element in the focusing group reduces aberrations during focusing. The lens is a compact, lightweight, and large-diameter wide-angle lens with the ability to provide 0.5x macro shooting, by using front-lens focus together with forward placement of the diaphragm and a lighter focus group. The lens has a minimum focusing distance of 0.17m (6.7 inches).

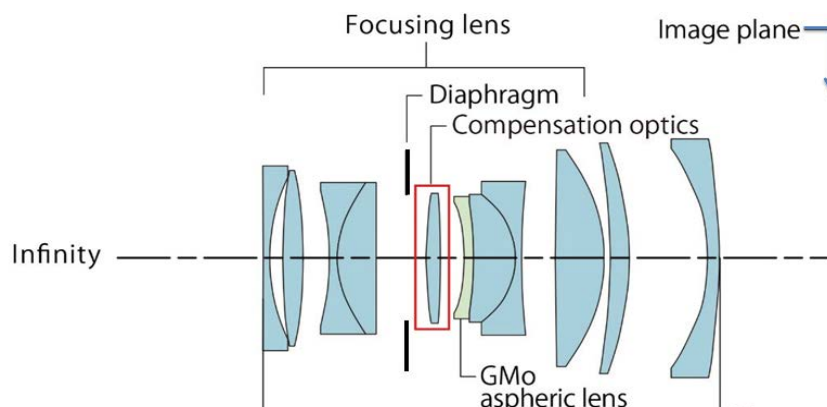

**Figure 31** Optical system of the new RF35mm F1.8 MACRO IS STM lens

The lens has the new control ring — with 54 clicks per revolution. It has a high performing optical image stabilization system with shake-correction allowing hand-holding at shutter speeds up to 5-Stops slower than would normally be possible — impressive for a lens having a brightness of F1.8.

In two key areas a notable improvement was implemented in this new 35 mm lens compared to the well-known EF35mm f/2 IS USM lens. The overall length of the lens's optical path is shortened from 105 mm to 80.5 mm and the all-important operational optical speed of the lens is now F1.8. Figure 32 shows EF 35mm f/2 IS USM on the left compared to the new lens on the right.

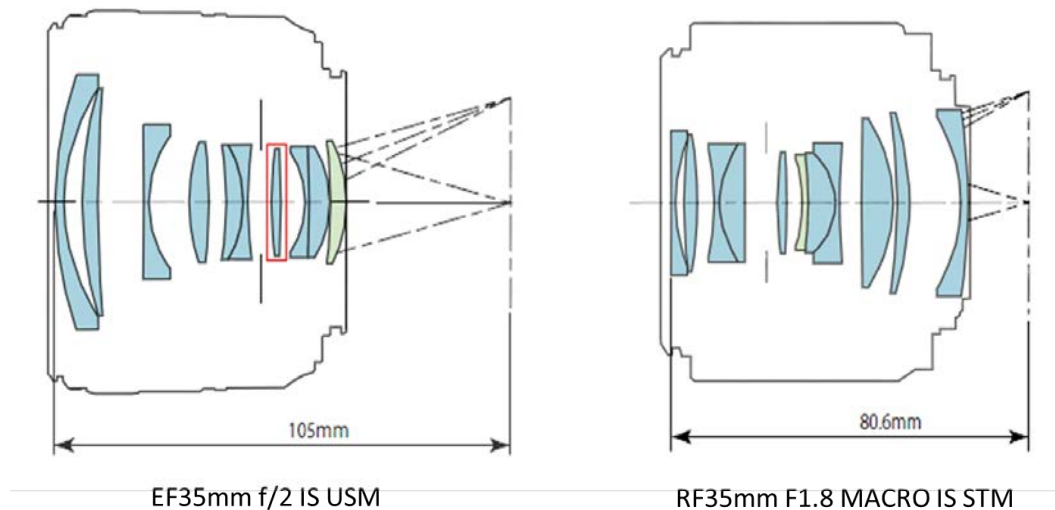

**Figure 32** *New RF35mm F1.8 MACRO IS STM lens (on the right) having a large diameter rear element helps optimize the overall image performance projected on to the full frame image sensor*

A comparative inspection of these two lenses quickly reveals a quite radical change to the overall optical assembly. Note the large final lens element of the RF35mm F1.8 MACRO IS STM compared to that of the EF lens. Of special interest are the smaller front elements in the new lens — which still achieves the faster F1.8 maximum aperture because of the large diameter iris that is positioned unusually near the front of the lens. The entire front section is moved to focus this latest 35 mm lens. But, it is much smaller-diameter and lighter in weight, making it possible to switch from a ring-type USM to the stepping motor (STM) focus drive system. Among other benefits, this change to STM focus drive means much smoother focus performance when the lens-camera system is used for video shooting.

RF35mm F1.8 MACRO IS STM

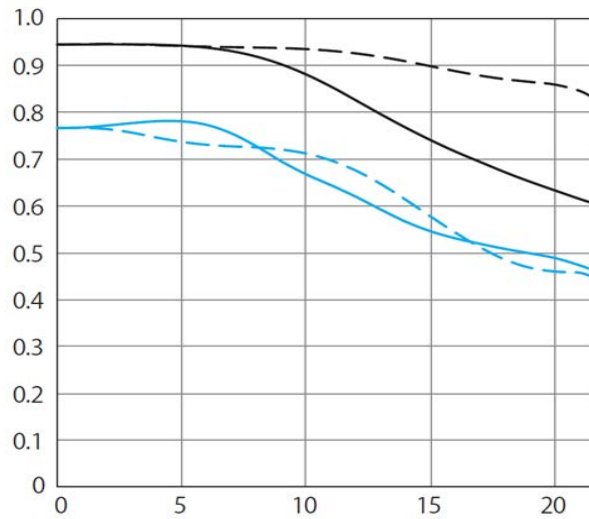
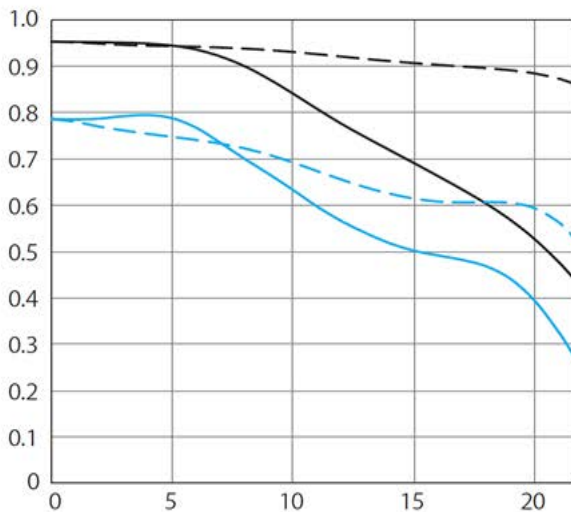

Figure 33 MTF curves for RF35mm F1.8 MACRO IS STM lens

EF35mm f/2 IS USM



EF35mm f/1.4L II USM

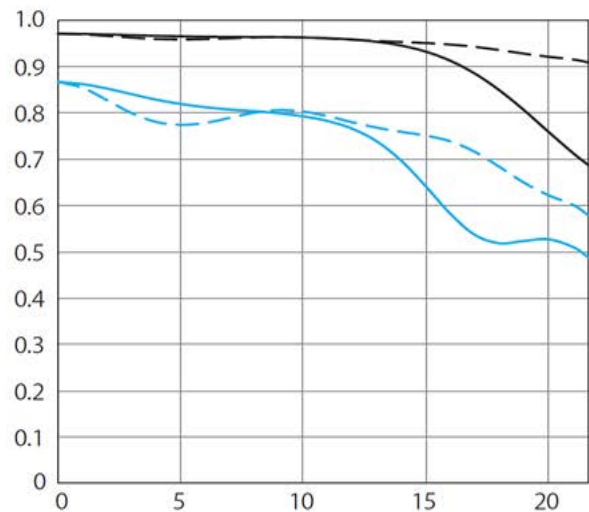

Figure 34 MTF characteristics of the new RF35mm F1.8 MACRO IS STM lens compared to two 35mm EF lenses

The new RF35mm F1.8 MACRO IS STM has remarkably similar MTF characteristics to those of the excellent EF35mm f/1.4L lens. But it is a more compact and lightweight lens and has a macro shooting capability at f/1.8 brightness that cannot be matched by any EF lens. The control algorithm of the new optical IS augments the Dual Sensing IS of the EOS R lens-camera system, providing high image stability in macro photography using up to 5 stops shutter speed.

1. 10 Lp/mm Sagittal for the new RF35mm F1.8 MACRO IS STM lens maintains a slightly higher MTF across the total image height compared to the EF35mm f/2 IS USM and is much lower than that of the EF35mm f/1.4L II USM
2. 10 Lp/mm Meridional exhibits a lower MTF than both EF 35mm lenses
3. 30 Lp/mm Sagittal for the RF35mm F1.8 MACRO IS STM is somewhat similar to that of the EF35mm f/2 IS USM out to 15mm height but slightly higher at maximum image height but is not as well controlled as the EF35mm f/1.4L II USM
4. 30 Lp/mm Meridional curve for RF35mm F1.8 MACRO IS STM lens is not as high as that of the EF35mm f/1.4L II USM and is somewhat similar to that of the EF35mm f/2 IS USM

## 12.0 EF LENS MOUNT ADAPTERS

The intent of the EOS R system is to build upon the highly successful Canon EOS system and take it to new levels of performance and operational flexibilities for both digital still and motion imaging. Central to the strategy is the Mount Core Design — the new RF mount. Folding the existing world of EF lenses (including EF-S lenses) into this expanding imaging universe is a pivotal part of the overall plan. To do this three special adapters have been developed:

### 1. Mount Adapter EF-EOS R

Direct mechanical and electrical coupling between the EF lens and any the new EOS R camera and any future EOS R cameras

### 2. Control Ring Mount Adapter EF-EOS R

An adapter for existing and future EF lenses that incorporates the same innovative new ring for control of exposure that is found on RF lenses. When the ring is rotated a built-in sensor and microprocessor detect and process that motion which is transmitted to the camera via the contacts

### 3. Drop-In Filter Mount Adapter EF-EOS R

A mount adapter for EF lenses, with dedicated drop-in filter slot. It allows addition of a Canon Drop-In Circular Polarizing Filter A (with full rotation capabilities in the adapter), or a Canon Drop-In Variable ND Filter A with range of 1.5–9 stops. An available Drop-In Clear Filter A should be used whenever the two specialized filters are not in-place.

## 12.1 Mount Adapter EF-EOS R

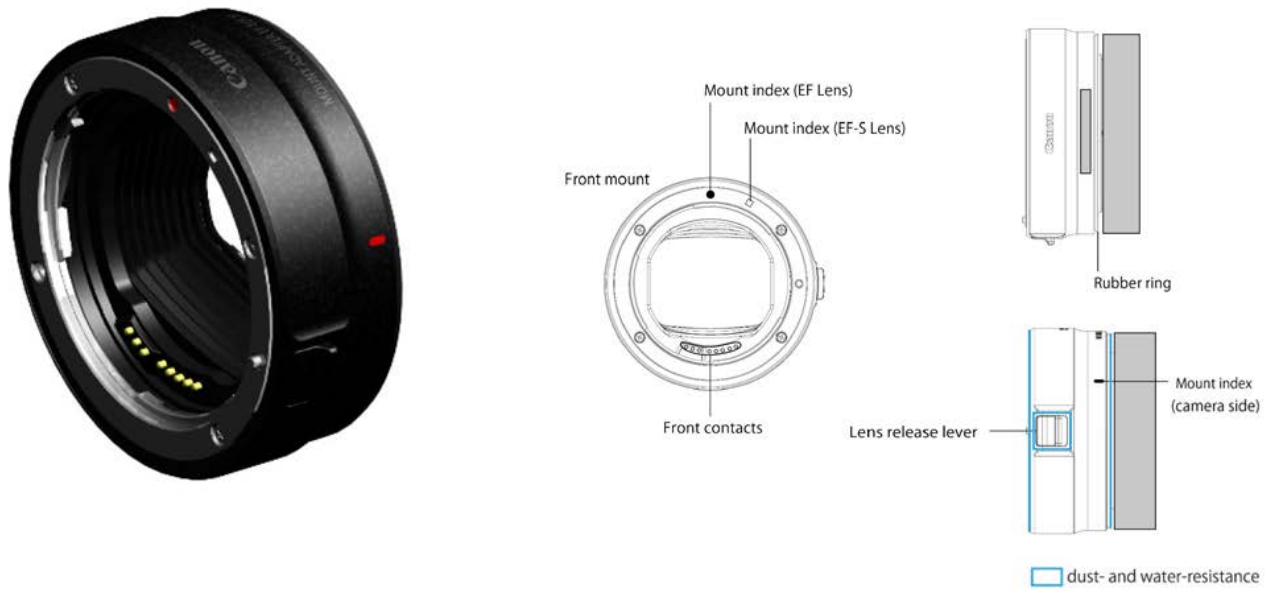

Figure 35 Mount Adapter EF-EOS R that adapts EF lenses to the new RF mount

## 12.2 Control Ring Mount Adapter EF-EOS R



Figure 36 Control Ring Mount Adapter EF-EOS R that incorporates the control ring

## 12.3 Drop-In Filter Mount Adapter EF-EOS R



**Figure 37** Drop-In Filter Mount Adapter EF-EOS R showing the various options for the drop-in optical filters

## 13.0 EOS R LENS-CAMERA SYSTEM

The EOS R system incorporates a variety of operational empowerments that have been made possible because of new innovation in the new lens series and the high-speed electronic communication between the lens and the camera.

### 13.1 Enhanced Image Stabilization System

High picture sharpness is ensured as long as each point of the image remains precisely positioned on the imager sensor. Lens-camera shake is a significant cause of blurred images. Minute deflections and tremors to the lens-camera momentarily shifts the projected image around the imager sensor plane — causing inadvertent image unsteadiness in the displayed image, with an associated blurring and loss of picture sharpness. These lens-camera disturbances include jolting associated with handheld and shoulder mounting by a camera operator who is in motion, vibrations when tripod mounted on an unstable platform or in windblown environments, to the higher vibration frequencies encountered when operating on vehicles, boats, and aircraft.

In the new EOS R system the lens embodies new technologies that combine with the IS system in the camera to implement an augmented control over the image blurring that can be caused by shaking and vibration of the lens-camera system. This is empowered by an interactive data communication between the two. Within the lens a dual gyro sensor system detects any inadvertent physical movements of the system and this data is reported across lens-camera communication to the DIGIC 8 processor. At the same time the image sensor is “seeing” any blur stimulated by these same movements and it also reports this image data to the DIGIC 8 processor. These two data reports are algorithmically processed at very high speed and a compensation control signal is generated and sent back at high speed to the lens to actuate the IS optical element that counteracts the disturbance.

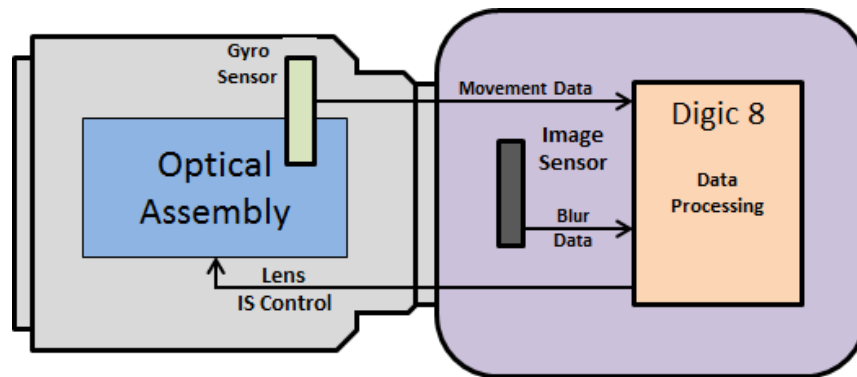

**Figure 38** The lens gyro sensor reports lens movements and the image sensor reports associated blur data to the DIGIC 8 processor

During video recording there is the added ability to combine any optical Image Stabilization in the lens with electronic Image Stabilization within the CMOS image sensor. Combination IS adds five axis degree of control electronic IS at the image sensor as shown in Figure 38, in addition to the up/down, left/right stabilization typically carried out in the lens. The lens IS system exercises correction in the Yaw, Pitch, and Roll directions — see Figure 39. The in-camera stabilization system exercises additional control over Yaw and Pitch — as well as correction in Roll and the vertical and horizontal planes.



**Figure 39** Showing the five dimensions of image stabilization correction in the EOS R camera

## 13.2 Digital Lens Optimizer (DLO) System

The Digital Lens Optimizing system is built into the EOS R camera and is intended to implement real-time corrections for a number of optical aberrations and distortions encountered over a wide range of shooting conditions. Before the light rays reach the CMOS image sensor they pass through the multi-element lens and various filters as illustrated in Figure 40.

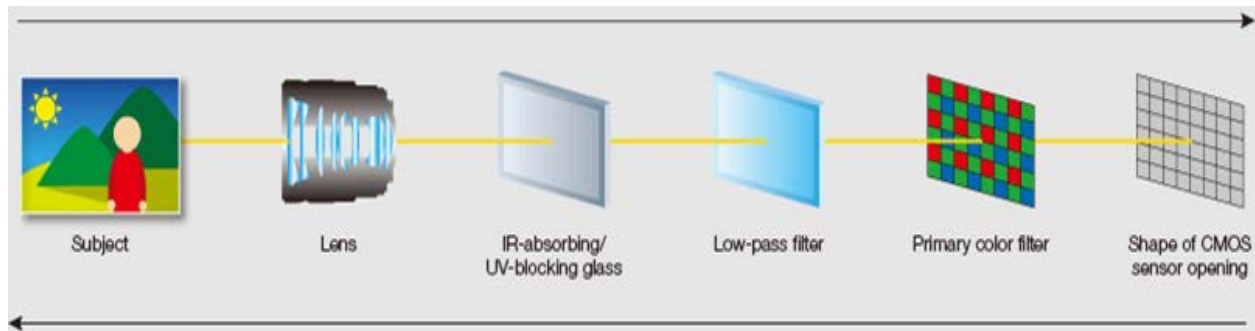

**Figure 40** A simplistic rendition of the path of the light ray that enter the lens and are ultimately projected on to the camera image sensor

A point light source that travels through a lens system encounters numerous aberrations — both monochromatic and chromatic — that tends to spread that light. The optical scientists speak of a Point Spread Function. However, the cumulative effect of the aberrations is to create a range of shapes in that spread function and they are affected by the image height and by the operational settings of zoom, focus, and iris.

There are two basic limitations to image resolution within all lenses — the first is the cumulative effect of the six monochromatic and chromatic aberrations (termed the defocusing distortions and which worsen as the lens aperture approaches maximum), and the second is diffraction (which worsens as the lens aperture is stopped down) — see Figure 41.

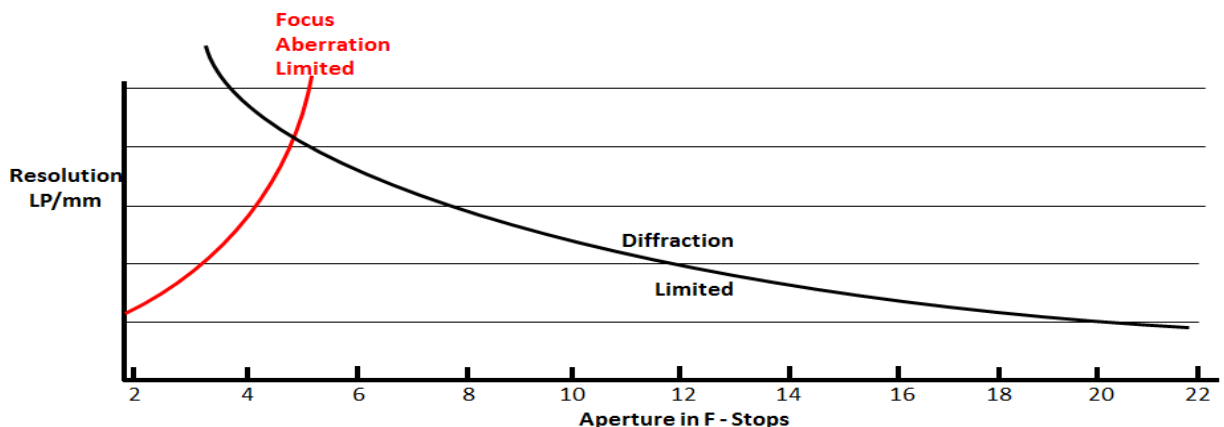

**Figure 41** Cumulative optical aberrations place limits on lens resolution near wide aperture settings and diffraction places other limits as the lens aperture is stopped down

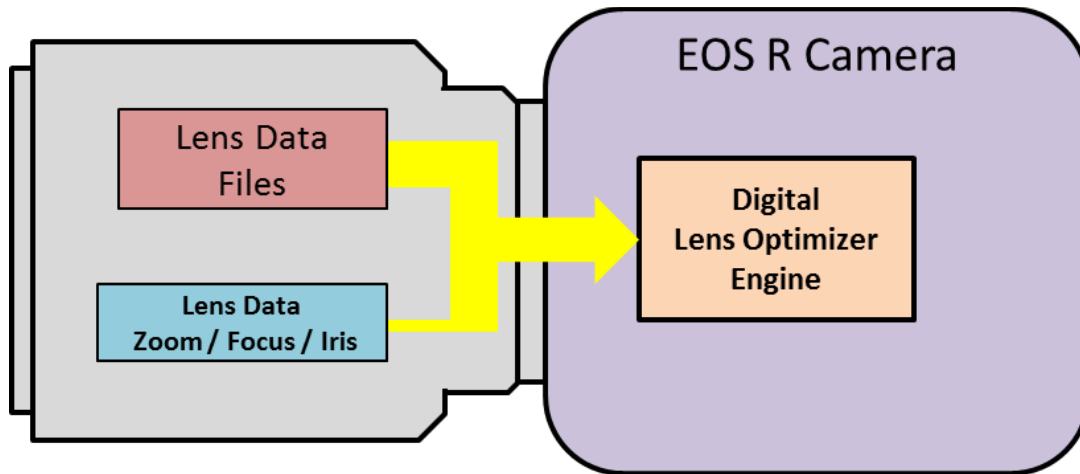

**Figure 42** Showing the stored data files on lens aberrations and the real-time lens operational controls communication across to the DLO engine within the EOS R camera

*The DLO system can implement corrections for the following*

1. Resolution loss due to cumulative aberrations
2. Resolution loss due to diffraction
3. Lateral chromatic aberration

The Digital Lens Optimizer is particularly useful when using lenses that are prone to optical distortion or blur, often providing substantial improvements in image quality.

In photographic circles, many will stop down slightly from maximum aperture when taking photos with a shallow depth of field for a blurry effect, or for scenes requiring a fast shutter speed. This is done to prevent a degradation of resolution in the focal area. When Digital Lens Optimizer is used, high image sharpness with minimal aberrations can be achieved even with maximum aperture. Whether using a fast shutter speed to capture a special moment, or a shallow depth of field for a blurry effect, the desired aperture can be chosen freely. A wider aperture also allows lowering the ISO speed for even better image quality.

Using a great depth of field for pan focus is one of the standard techniques of photography. But this involves a tradeoff, because small apertures could not be used if softening of the image caused by the diffraction effect was to be avoided. With the Digital Lens Optimizer, the entire range, from fully open to minimum aperture, can be used, giving free reign to creativity. Even at middle range F-stops, where image quality is generally good, aberrations and diffraction used to reduce image quality to a certain extent. Shutter speed can be at will, regardless of aperture stop.

In the EOS R system, Digital Lens Optimizer can be applied in-camera when the RAW files are converted to JPEG image files, and users can expect improvements in fine detail and resolution, especially with subjects having lots of inherent detail (think grass and foliage in landscapes, textures in fashion fabrics, etc.). If RAW images are recorded and then processed in Canon's Digital Photo Professional software, similar benefits can be applied in processing the images.

### 13.3 Dual Pixel CMOS AF

EOS R system embodies a powerful auto focus system where the sensing of sharp focus takes place within the image sensor photosite itself. It mobilizes the dual photodiodes within each photosite to create two separate images that facilitates a phase detection system that indicates the degree of defocusing.

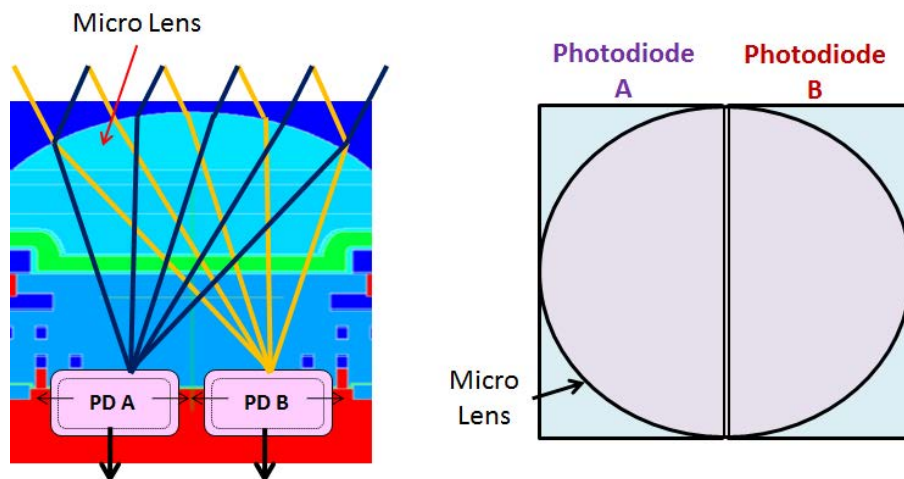

**Figure 43** Showing the dual photodiode structure of a single photosite in the CMOS image sensor used in the EOS R camera

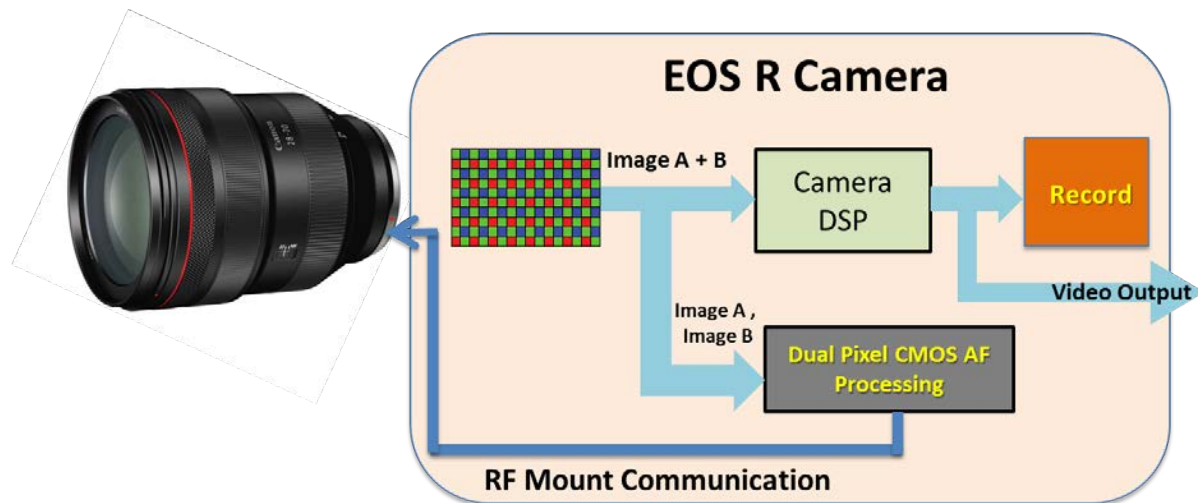

**Figure 44** Showing the separate processing of the dual pixel data from the image sensor — for video and for Auto Focus — at the entry stage of the Digic 8 processor

Figure 44 illustrates the manner in which the sets of dual pixel outputs from the CMOS image sensor are sent to the DIGIC 8 processing microcircuit that was developed by Canon. Within this processor, these streams are separately fed to the primary RGB video processing system (where the two photodiode signals are summed) and to a data processing system that analyzes the phase difference between the two and makes all of the decision-making and data processing associated with the Auto Focus system. While all of the millions of photosites are delivering the “dual pixel” data, the operational aspects of Auto Focus dictate that only a select number of these are activated at any given time. This is because the camera operator (or for the camera, when AF methods like Face Detect + Tracking are active) will make the decision on which particular subject within the overall picture frame is chosen for sharpest focus. Consequently, a cursor type system must be implemented to facilitate this choice. Experiences gained in the early generations of Dual Pixel CMOS AF systems produced the following:

1. Broad request to provide spatial movement of the sampling area — so that different subjects within a given scene can be selected for sharpest focus
2. Ranging performance improvement is needed in low scene illumination situations
3. Improvement in accuracy of the system as ISO setting increased
4. Auto focus should ideally be a realtime action (or as close as possible to realtime) so speed of calculations should be increased
5. Improvement in the calculating algorithm to elevate reliability

A more dense sampling lattice of photosites for the cursor was developed to increase sensing sensitivity and accuracy over a wider range of scene illumination and camera ISO settings. The cursor size can be adjusted to accommodate the specific AF needs of a given scene and situation.

It can range across the image plane according to the discrete manually “Selectable AF Points” outlined in Figure 45. There are 87 positions horizontally (covering 88% of the image width) and 65 positions vertically (covering 100% of the image height) for these selectable AF points. This ensures very precise auto focus operation.

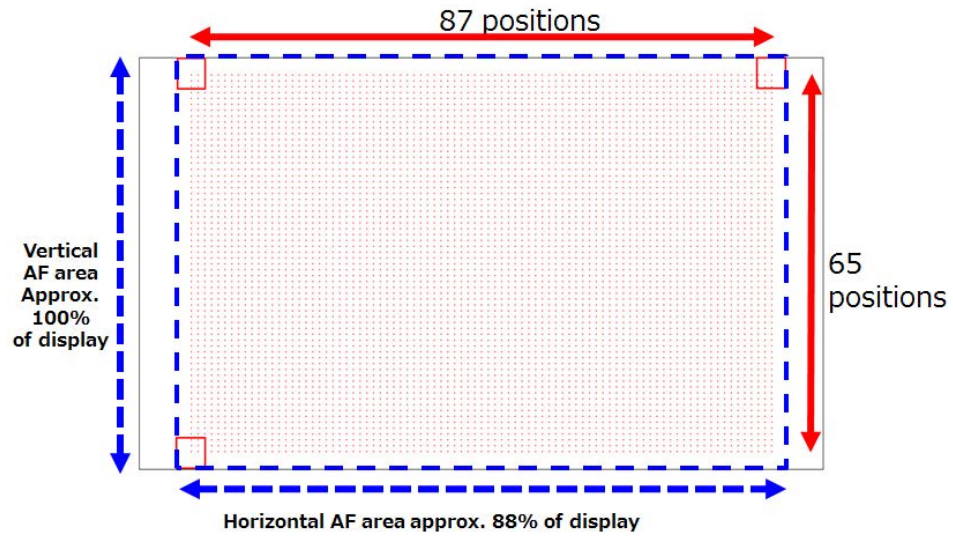

**Figure 45** *Showing the disposition of the discrete locations which is manually selectable*

## 13.4 Comparison of EOS R Lens-Camera System with EF Lens and DSLR

A sense of the significant compactness that the EOS R camera system can offer is shown in the outline drawing of Figure 46 which compares it to the Canon EOS 5D Mark IV.

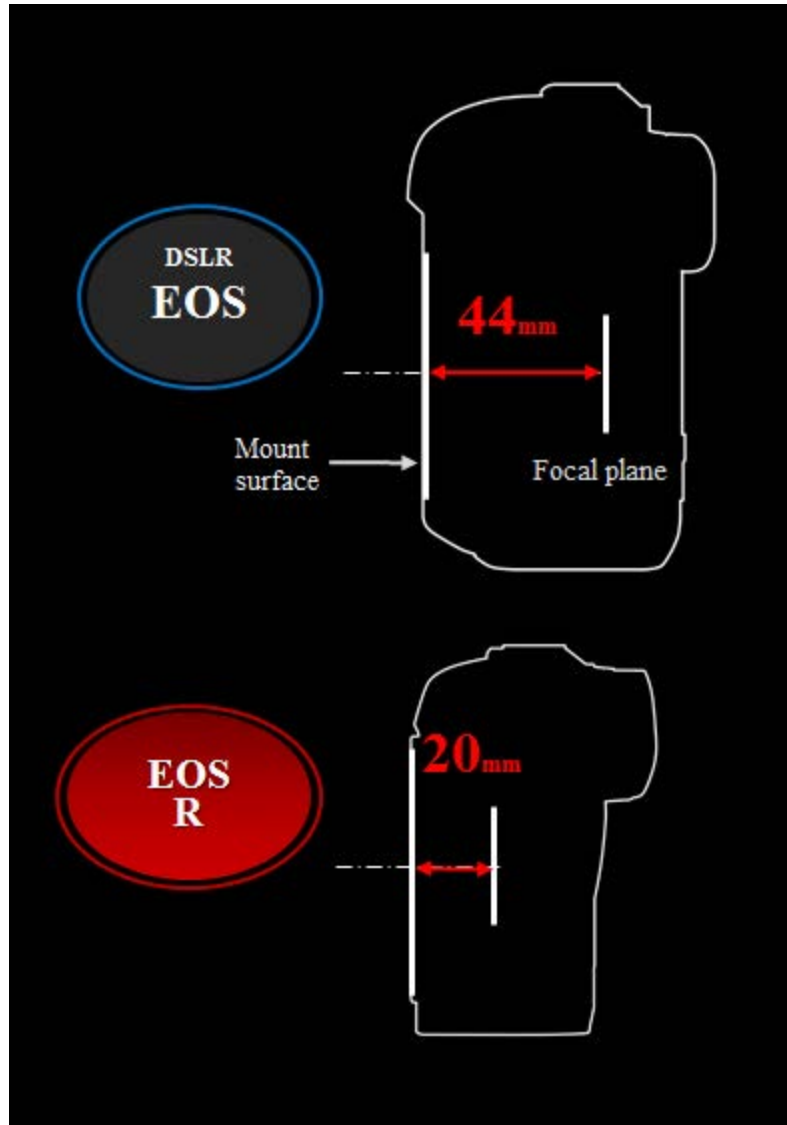

**Figure 46** Outline drawing of a new EOS R camera system (lower) compared to an equivalent Canon EOS 5D Mark IV camera (upper)

The EOS R system has a flange focal distance of just 20mm, a distance that was carefully optimized to support the optimal optical conditions provided by a short back focal distance and the mechanical rigidity needed to reliably support a heavy lens.

A more dramatic illustration is shown in Figure 47 — which effectively conveys how the new lens and mount have very effectively shortened the overall length of the lens-camera system.



**Figure 47** Showing the RF24-105mm F4 L IS USM lens mounted to the first EOS R camera (right side of picture) side by side with an equivalent EF lens on a Canon EOS 5D Mark IV camera (left side)

## 14.0 SUMMARY

The EOS system is hugely established across the globe and continues to move in new directions — as the lines between still and motion imaging blur and as lens-camera image quality steadily increases with every generation. Applications of still and motion imaging have seen extraordinary advances at all levels — from amateur all the way to the highest professionals. Collectively, aesthetic aspirations and creative ingenuities of the end users are escalating — and the bar continues to be elevated in requirements for both image quality and operational freedoms.

The recognition that all that is best about the EOS system must be supported into the future is tempered by an acknowledgement that new design options needed to be opened. The new EOS R system was spawned by the vast accumulation of EOS system experiences over the past decades, by accelerating technological advances in optics, image sensors and digital image processing over more recent years, and by a growing recognition that ongoing enhancements to the system would require more degrees of design freedom for lenses and cameras.

A long examination by Canon R&D and Lens Development groups — on both the optical and camera side — concluded that optics was central to a new future strategy. In the context of the digital camera, Moore's Law remains amazingly resilient from its first promulgation at the end of the 1970's — there as yet seems no end in sight. As a consequence, digital camera processing has benefited to an extraordinary level — as testified by the huge range available today, their continuing performance elevations, and their steadily decreasing size and weight. It must be anticipated this will continue.

Lenses, on the other hand, enjoy no equivalent technological stimulant. The sciences of optics and optomechanics advance methodically. Yet, the dictates of higher optical performance, greater flexibilities in operational specifications, and the intractable constraints of size and weight of lenses are pivotal to supporting future prospects in imaging. EOS R system was born on the basis of decisively removing some constraints on lens designs.

Central to the new EOS R system strategy was the recognition that the large 54 mm diameter of the EOS system would continue to pay optical dividends far into the future. But the 44 mm flange back distance had surfaced as a constraint whose time had come to be dealt with. Significantly shortening this distance would yield immediate new degrees of freedom in optical design. But this, of necessity, would have to be balanced with rigidity of the new mount, ease of attaching and detaching lenses, durability, dust and drip resistance. In-depth design reviews within Canon yielded the new RF lens mount — preserving the 54 mm inner diameter while significantly shortening the flange back to 20 mm. Now, positioning of large diameter lens elements much closer to the image sensor (especially the full frame sensor) would support an important enhancement of image quality.

This paper has discussed details of the new RF lens mount. The advantages of this new mount design are immediately evident in the designs of the first four lenses of the RF lens family — as outlined in this paper.